



2024

ZÁHRADA

T.TAKÁCS
VEĽKOOBCHOD

Florcom[®]

 **ICL**

Modiform[®]

Orgánica 
de sustratos

floser[®]

KLASMANN  **DEILMANN**
we make it grow

ipp
INTERPLAST PLASTIC PRODUCTS

terra  **san**[®]

 **Prosperplast**[®]



Bradas

B  **O PON**

fitt 

 **JUTA**

FELCO
SWISS  MADE

FISKARS[®]

 **BARENBRUG**

 **DLF**
SEEDS & SCIENCE 

OBSAH

SUBSTRÁTY, RAŠELINA, KÔRA	2-17
HNOJIVÁ	18-33
OSIVÁ	34-37
PRÍSLUŠENSTVO K TRÁVNIKOM	38-40
KVETINÁČE, MULTIPLATÁ	41-59
CHÉMIA	60-69
BAZÉNOVÁ CHÉMIA A PRÍSLUŠENSTVO	70-75
TEXTÍLIE	76-77
ZÁHRADKÁRSKE POTREBY	78-112
ZÁHRADNÉ OSVETLENIE	113-133
KAMENE	134-147

Firma si vyhradzuje právo na zmenu produktov.

Aktuálne produkty nájdete aj
v objednávkovom systéme:

www.takacs.sk



ZÁHRADNÍCKY SUBSTRÁT

Univerzálny substrát so širokou možnosťou použitia na pestovanie kvetín, zeleniny, drevín a vylepšenia pôdy na záhonoch. Substrát je vyrobený z kvalitnej vrchoviskovej rašeliny, kompostovanej kôry a prírodného humusu. Je obohatený živinami, vyznačuje sa trvalo stabilnou štruktúrou.



Kód	balenie	pal.
2200	10 l	238
2300	20 l	132
2350	50 l	51
2400	75 l	39



BALKÓNOVÉ KVETY

Špeciálny substrát pre balkónové rastliny, najmä pre Pelargonie, ktoré sú náročné na živiny. Substrát je vyrobený z kvalitnej vrchoviskovej rašeliny, kompostovanej kôry, prírodného humusu a čistého ílu. Je výdatne obohatený živinami a stopovými prvkami, vyznačuje sa trvalo stabilnou štruktúrou, ktorá zaručuje optimálne prevzdušnenie a vododržnosť. Vďaka svojim vlastnostiam zaručuje veľký nárast a bohaté kvitnutie všetkých balkónových rastlín vrátane muškátov.



Kód	balenie	pal.
600	10 l	238
700	20 l	132
800	50 l	51
900	75 l	39



IZBOVÉ RASTLINY

Substrát určený pre pestovanie väčšiny izbových rastlín okrasných kvetom a listom. Substrát je vyrobený z kvalitnej vrchoviskovej rašeliny, kompostovanej kôry a prírodného humusu. Je obohatený živinami a vyznačuje sa trvalo stabilnou štruktúrou, vytvára priaznivé podmienky pre rast a zdravý vývoj izbových rastlín.



Kód	balenie	pal.
100	5 l	270
200	10 l	238
300	20 l	132



VÝSEVNÝ

Substrát je určený pre výsevy semien kvetín a zeleniny. Ďalej slúži pre množenie kvetín a drevín odrezkami. Substrát je vyrobený z jemných triedených rašielín s prídavkom kremičitého piesku a humusu.



Kód	balenie	pal.
1600	10 l	238
1700	20 l	132



NEW

FARMÁRSKY

Substrát je určený pre ekologické pestovanie, do vyvýšených záhonov bez použitia minerálnych hnojív.



Kód	balenie	pal.
2420	50 l	51



OKRASNÉ DREVINY

Špeciálny substrát určený pre vysádzanie a pestovanie ihličnatých i listnatých kríkov a stromov. Substrát je vyrobený z kvalitnej kyslej vrchoviskovej rašeliny, kompostovanej kôry a prírodného humusu. Je obohatený živinami a stopovými prvkami.



Kód	balenie	pal.
2100	75 l	39



PRE KONIFERY

Špeciálna výživná zmes na pestovanie všetkých druhov ihličnanov. Obohatená všetkými dôležitými živinami pre dosiahnutie rýchlych prírastkov. Zaisťuje ideálne vzdušnú pôdnu štruktúru pre zdravý vývoj koreňovej sústavy.

Kód	balenie	pal.
2110	45 l	57



RAŠELINA

Kvalitná vrchovisková biela rašelina, vhodná na obohatenie pôdy o organické látky, k okysleniu alkalických pôd a k výraznému zlepšeniu chemických a fyzikálnych vlastností pôd. Rašelina je čistý organický produkt, nemá upravené pH a nemá pridané živiny.



Kód	balenie	pal.
5100	20 l	132
5200	75 l	39



TRÁVNIKOVÝ s kompostom a pieskom

Špeciálny substrát so stabilnou štruktúrou na báze kvalitného drveného kôrového a zeleného kompostu a rašeliny. S prídavkom triedeného piesku pre vylepšenie drenážnych vlastností a zabraňovaniu hromadenia vlhkosti.



Kód	balenie	pal.
2450	45 l	42



TRÁVNIKOVÝ s kremičitým pieskom Premium

Ťažší typ vzdušného jemného substrátu s kremičitým pieskom, optimálne vyhnojovaný, s neutrálnym pH pre výsevy, rekonštrukcie trávnikov a ako podklad pre pokladanie kobercových trávnikov. Je tiež vhodný pre doplňovanie už vyrastených trávnikov, kde obmedzí plstnatenie, tvorbu machov, zaisťujú dobrú drenáž a dodá trávniku živiny.



Kód	balenie	pal.
2440	40 l	42



PRE SURFÍNIE

Pre kyslomilné balkónové rastliny, najmä pre previsnuté petúnie, surfínie, Million Bells, Begonie, Fuchsie, ktoré sú náročné na živiny, nižšie pH a vysoký obsah železa. Substrát je vyrobený z kvalitnej kyslej vrchoviskovej rašeliny, kompostovanej kôry a prírodného humusu. Je výdatne obohatený živinami a stopovými prvkami, najmä železom v chelátovej forme. Spoločne s kyslou reakciou a dobrou zásobou živín zabraňuje tvorbe chloróz.



Kód	balenie	pal.
1020	50 l	51



PRE PARADAJKY A ZELENINU

Substrát pre paradajky a zeleninu sa používa na pestovanie paradajok, papriek, uhoriek, zeleniny a ostatných rastlín, vyžadujúcich strednú zásobu živín, pestovaných v pestovateľských nádobách a aj v záhonoch. Je tiež vhodný na vylepšenie pôdy v záhonoch pri výsadbe. Nie je vhodný pre výsev a pre rastliny citlivé na obsah solí!



Kód	balenie	pal.
1750	50 l	51



RODODENDRÓNY A AZALKY

Špeciálny substrát určený na presádzanie a pestovanie rododendrónov, azaliiek, vresov, vresovcov, čučoriedok, brusníc a ďalších kyslomilných rastlín. Je tiež vhodný pre úpravu príliš alkalickej voľnej pôdy a alkalickej pôdy v kvetináčoch. Substrát je vyrobený z kvalitnej kyslej vrchoviskovej rašeliny, kompostovanej kôry a prírodného humusu.



Kód	balenie	pal.
1350	50 l	51



PRE ČUČORIEDKY A BRUSNICE

Substrát so stopovými prvkami a živinami, vhodnou kyslostou, optimálnou vododržnosťou a dostatkom vzduchu zaisťujú zdravý vývoj koreňového systému a bohatú úrodu. Navyše obsahuje zeolit, ktorý má vynikajúce vlastnosti na výmenu iónov a zabraňuje vyplaveniu živín. Substrát je vhodný pre pestovanie čučoriedok a brusníc, ale aj ostatných kyslomilných rastlín, ktoré sú náročné na stabilne nižšie pH a na dostatok živín a vlahy.



Kód	balenie	pal.
1050	50 l	51



ZÁHRADNÍCKY KOMPOST

Substrát z vysokým obsahom fosforu, draslíka a vápnika. Je zvlášť vhodný pre zlepšovanie pôd pred výsadbu škôlkarského materiálu, pre sadovnícku realizáciu, pred založením trávniku, záhonov, alebo ako prísada do substrátu, ktorá zadržiava vlhkosť a obsahuje veľké množstvo živín.



Kód	balenie	pal.
4230	40 l	42
4220	1 m ³	1



PRE JAHODY

Substrát pre jahody sa používa pre pestovanie jahôd a iného drobného ovocia v pestovateľských nádobách (kontajnery, kvetináče ...), na nadzemných záhonoch a v záhonoch. Substrát vytvára priaznivé podmienky pre zdravý vývoj rastlín.



Kód	balenie	pal.
1756	50 l	51



PRE LEVANDULE A STREDOMORSKÉ RASTLINY

Substrát pre stredomorské rastliny a levandule sa používa na pestovanie stredomorských rastlín, levandule, stredomorských bylín a paliem. Substrát je vhodný na pestovanie v nádobách i vo voľnej pôde. Substrát vytvára priaznivé podmienky pre zdravý vývoj rastlín.



Kód	balenie	pal.
1752	20 l	132



SUBSTRÁT PRE CITRUSY A SUBTROPICKÉ RASTLINY

Určený pre pestovanie citrusov, oleandrov, olivovníkov, paliem a všetkých ďalších stredomorských rastlín vysadených v záhone, v nádobách, alebo aj izbových rastlín letnených vonku v kvetináčoch. Pri výsadbe do záhona je potrebné vyhlbiť dostatočne veľkú jamu. Po zasadení rastliny priestor vyplňte substrátom, ľahko ho pritlačte a dôkladne zalejte. Po šiestich týždňoch začnite s pravidelným hnojením NPK hnojivom, prípadne špeciálnym hnojivom pre citrusy.



Kód	balenie	pal.
1754	20 l	132



PRE ORCHIDEJE

Špeciálny substrát na pestovanie a presádzanie orchideí. Substrát je vyrobený z kvalitnej píniovej kôry a hrubej bielej rašeliny. Táto hrubozrnná zmes zaručuje optimálne podmienky pre zdravý rast a bohaté kvitnutie orchideí.



Kód	balenie	pal.
550	5 l	270



PRE ORCHIDEJE

Špeciálna zmes upravených drvených kokosových vlákien a obalov kokosových orechov, ktoré zaisťujú orchideám optimálny rast, kvitnutie a dostatok vzduchu v substráte. Tieto kokosové vlákna je možné ďalej miešať s rašelinou a píniovou kôrou podľa nárokov jednotlivých druhov orchideí. Tento substrát je zlisovaný do malej kocky, ktorá po namočení do vody zväčší svoj objem až na 4 litre substrátu.



Kód	balenie	pal.
910	350 g	-



S KOKOSOM PRE BALKÓNOVÉ KVETY

Špeciálna zmes upravených drvených kokosových vlákien a obalov kokosových orechov určená pre pestovanie a úpravu substrátu izbových a balkónových rastlín. Zvlášť vhodný substrát pre rastliny, ktoré potrebujú vzdušný, ľahký a štruktúrovaný substrát. Tento substrát je zlisovaný do malej kocky, ktorá po namočení do vody zväčší svoj objem až na 7 litrov substrátu.



Kód	balenie	pal.
920	450 g	-

Florcom QUALITY



ZÁHRADNÍCKY

Univerzálny substrát pre pestovanie kvetín, zeleniny, drevín a vylepšenia pôdy na záhonoch. Vyznačuje sa stabilnou štruktúrou s vynikajúcou zásobou vzduchu a sorpciou vody. Je obohatený základnými živinami a mikroprvkami pre správny rast a vývoj rastlín. Je vhodný na pestovanie rastlín na záhonoch, v nádobách a tiež na vylepšovanie pôdy pri výsadbách nielen na záhrade.



Kód	balenie	pal.
2301	20 l	132
2351	50 l	51
2401	75 l	39



PRE BYLINKY A KORENIE

Špeciálny substrát s ideálnou štruktúrou pre pestovanie bylín a korenia v nádobách doma i vonku, ktorý je vhodný aj pre ich výsevy. Vyznačuje sa vynikajúcou vododržnosťou a vzdušnou kapacitou a vytvára tak priaznivé podmienky pre rast a zdravý vývoj rastlín. Použitie tohto špeciálneho substrátu je jedným z predpokladov pre radosť aj úžitok z vlastnej voňavej bylinkovej záhrady.



Kód	balenie	pal.
1251	20 l	132



IZBOVÉ KVETY

Substrát určený pre pestovanie väčšiny izbových rastlín okrasných kvetom a listom. Vyznačuje sa dlhodobou stabilnou štruktúrou a vytvára priaznivé podmienky pre zdravý rast a vývoj izbových rastlín. Substrát neobsahuje fermentovanú kôru ani kompost, je optimálne vzdušný a vododržný. Eliminuje výskyt plesní a mušiek a prináša tak radosť z úspešného pestovania na dlhý čas.



Kód	balenie	pal.
201	10 l	238
301	20 l	132



BALKÓNOVÉ KVETY

Špeciálny substrát pre balkónové rastliny, najmä pre Pelargónie, ktoré sú náročné na živiny. Je výdatne zásobený živinami a stopovými prvkami. Vyznačuje sa trvalo stabilnou štruktúrou, ktorá zaručuje optimálne prevzdušnenie a vododržnosť. Vďaka svojim vlastnostiam zaručuje vitalitu, veľký nárast, bohaté kvitnutie a vyfarbené kvety nielen muškátov, ale všetkých balkónových rastlín.



Kód	balenie	pal.
701	20 l	132
801	50 l	51
901	75 l	39



SUBSTRÁT MYKOFLOR

Univerzálny s mykorhizou.

Najkvalitnejšia borkovaná biela rašelina 70%
 Frézovaná biela rašelina 30%
 Zeolit v 40 kg/m³
 6 druhov symbiotických mykorhíznych húb
 Start&Gro 14 - 16 - 18 so stopovými prvkami 1,5 kg/m³
 Dolomitický vápenec s vysokým obsahom horčíka
 pH 5,6 – 6,1
 EC 1,2 - 1,4 mS/cm²

Kód	balenie	pal.
4192	75 l	39



PRE BALKÓNOVÉ RASTLINY

Určený pre pestovanie všetkých balkónových rastlín okrasných kvetom aj listom, zvlášť všetkých druhov pelargónie. Je tiež ideálny pre všetky druhy záhonových letničiek.

Najkvalitnejšia borkovaná biela rašelina 70%
 Frézovaná biela rašelina 30%
 Zeolit v 40 kg/m³
 PG mix 14 - 16 - 18 so stopovými prvkami 1,5 kg/m³
 Dolomitický vápenec s vysokým obsahom horčíka
 pH 5,6 - 6,1
 EC 1,2 - 1,4 mS/cm²

Kód	balenie	pal.
4110	75 l	39



S HYDROGELOM

Určený pre pestovanie všetkých balkónových rastlín okrasných kvetom aj listom v nádobách, kde sa vďaka hydrogelu zníži frekvencia zálievok.

Najkvalitnejšia hrubá borkovaná biela rašelina 70%
 Frézovaná biela rašelina 30%
 Zeolit v 40 kg/m³
 PG mix 14 - 16 - 18 so stopovými prvkami 1,5 kg/m³
 Dolomitický vápenec s vysokým obsahom horčíka
 pH 5,4 - 5,9
 EC 1,2 - 1,4 mS/cm²

Kód	balenie	pal.
4115	75 l	39



PRE RODODENDRÓNY, AZALKY A VRESY

Určený pre pestovanie a výsadbu rododendronov, azaliek a ďalších vresoviskových kyslomilných rastlín.

Najkvalitnejšia borkovaná biela rašelina 50%
 Frézovaná biela rašelina 50%
 Zeolit v 20 kg/m³
 PG mix 14 - 16 - 18 so stopovými prvkami 1,2 kg/m³
 Železo v chelátovej forme 40 g/m³
 pH 4,0 - 4,6
 EC 0,8-1,0 mS/cm²

Kód	balenie	pal.
4130	75 l	39



SUBSTRÁT VÝSEVNÝ

Určený pre výsev kvetín, zeleniny a okrasných drevín.

Najkvalitnejšia borkovaná biela rašelina 45%
 Frézovaná biela rašelina 45%
 Kremičitý piesok 10%
 PG mix 14 - 16 - 18 so stopovými prvkami 0,6 kg/m³
 Dolomitický vápenec s vysokým obsahom horčíka
 pH 5,5 - 6,0
 EC 0,6 - 0,8 mS/cm²

Kód	balenie	pal.
4210	75 l	39

PROFI substráty

F02

Univerzálny substrát určený pre vylepšenie štruktúry pôdy na záhonoch a pestovaní mnohých druhov kvetín, zeleniny, okrasných a ovocných drevín.

Frézovaná biela rašelina 90%
Čierna rašelina 10%
PG mix 14 - 16 – 18 so stopovými prvkami 1 kg/m³
pH 5,6 – 6,3
EC 1,2 – 1,4 mS/cm²



Florcom
PROFESSIONAL

Kód	balenie	pal.
4420	250 l	18
4425	5,8 m ³	1

F02Z

Univerzálny substrát určený pre vylepšenie štruktúry pôdy na záhonoch a pestovaní mnohých druhov kvetín, zeleniny, okrasných a ovocných drevín.

Frézovaná biela rašelina 90%
Čierna rašelina 10%
PG mix 14 - 16 – 18 so stopovými prvkami 1 kg/m³
pH 5,6 – 6,3
EC 1,2 – 1,4 mS/cm²
Zeolit v 30 kg/m³



Kód	balenie	pal.
4430	250 l	18
4435	5,8 m ³	1

B02

Špeciálny substrát určený pre pestovanie všetkých druhov črepníkových, balkónových kvetín a trvaliek.

Najkvalitnejšia borkovaná biela rašelina 60%
Frézovaná biela rašelina 30 %
Čierna rašelina 10 %
Start&Gro 14-16-18 so stopovými prvkami 1,5 kg/m³
MICROMAX Premium 100 g/m³
Dolomitický vápenec s vysokým obsahom horčíka
Zvlhčovacie činidlo 100 ml/m³
pH 5,6–6,2



Kód	balenie	pal.
4455	250 l	18
4456	5,8 m ³	1

B02Z

Špeciálny substrát určený pre pestovanie všetkých druhov črepníkových, balkónových kvetín a trvaliek.

Najkvalitnejšia borkovaná biela rašelina 60%
Frézovaná biela rašelina 30 %
Čierna rašelina 10 %
Zeolit 40 kg/m³
Start&Gro 14-16-18 so stopovými prvkami 1,5 kg/m³
MICROMAX Premium 100 g/m³
Dolomitický vápenec s vysokým obsahom horčíka
Zvlhčovacie činidlo 100 ml/m³
pH 5,6–6,2



Kód	balenie	pal.
4465	250 l	18
4466	5,8 m ³	1

SVB

Substrát určený pre výsev a množenie rastlín.

100% borkovaná rašelina
0,7kg/m³ PGmix
pH 5,5 - 6,0



Florcom
PROFESSIONAL

Kód	balenie	pal.
4450	250 l	18
4451	5,8 m ³	1

B12Z

Špeciálny substrát určený pre pestovanie všetkých druhov črepníkových, balkónových kvetín a trvaliek.

Najkvalitnejšia borkovaná biela rašelina 60%
Frézovaná biela rašelina 30%
Čierna rašelina 10%
Zeolit 40 kg/m³
Start&Gro 14-16-18 so stopovými prvkami 1,5 kg/m³
MICROMAX Premium 100 g/m³
Dolomitický vápenec s vysokým obsahom horčíka
zvlhčovacie činidlo 100 ml/m³
pH 5,6–6,2



Kód	balenie	pal.
4470	250 l	18
4471	5,8 m ³	1

SCH02

Špeciálny substrát určený pre pestovanie všetkých druhov črepníkových chryzantém.

Najkvalitnejšia borkovaná biela rašelina 60%
Frézovaná biela rašelina 30%
Čierna rašelina 10%
Zeolit v 40 kg/m³
PG mix 14 - 16 - 18 so stopovými prvkami 1,5 kg/m³, LAV 1 kg/m³
Dolomitický vápenec s vysokým obsahom horčíka
pH 5,6 – 6,2
EC 1,4 – 1,8 mS/cm²



Kód	balenie	pal.
4475	250 l	18
4476	5,8 m ³	1

SCH03

Špeciálny substrát určený pre pestovanie všetkých druhov črepníkových chryzantém.

Najkvalitnejšia borkovaná biela rašelina 60%
Frézovaná biela rašelina 30%
Čierna rašelina 10%
Zeolit v 40 kg/m³
PG mix 14 - 16 - 18 so stopovými prvkami 1,5 kg/m³, LAV 1 kg/m³
Dolomitický vápenec s vysokým obsahom horčíka
pH 5,6 – 6,2
EC 1,4 – 1,8 mS/cm²



Kód	balenie	pal.
4478	250 l	18
4479	5,8 m ³	1

PROFI substráty

SBS-SK

Špeciálny substrát určený pre pestovanie previslých petúnií a všetky kyslomilné rastliny.

Najkvalitnejšia borkovaná biela rašelina 60%
Frézovaná biela rašelina 40%
Zeolit v 40 kg/m³
PG mix 14 - 16 - 18 so stopovými prvkami 1,5 kg/m³
Dolomitický vápenec s vysokým obsahom horčíka
Železo v chelátovej forme 40 g/m³
pH 4,5 - 4,9
EC 1,4 - 1,6 mS/cm²



Kód	balenie	pal.
4485	250 l	18
4486	5,8 m ³	1

B12Z KOKOS

Profesionálny substrát s kokosom pre pestovanie citlivých rastlín.

Najkvalitnejšia borkovaná biela rašelina 60%
Frézovaná biela rašelina 40%
Kokosové vlákno 10%
Zeolit v 30 kg/m³
Start&Gro 14 - 16 - 18 so stopovými prvkami 1 kg/m³
Dolomitický vápenec s vysokým obsahom horčíka
pH 5,8 - 6,2
EC 1,2 - 1,4 mS/cm²



Kód	balenie	pal.
4495	250 l	18
4496	5,8 m ³	1

B13Z KOKOS

Profesionálny substrát s kokosom pre pestovanie citlivých rastlín.

Najkvalitnejšia borkovaná biela rašelina 60%
Frézovaná biela rašelina 40%
Kokosové vlákno 10%
Zeolit v 30 kg/m³
Start&Gro 14 - 1 - 18 so stopovými prvkami 1 kg/m³
Dolomitický vápenec s vysokým obsahom horčíka
pH 5,8 - 6,2
EC 1,2 - 1,4 mS/cm²



Kód	balenie	pal.
4500	250 l	18
4501	5,8 m ³	1



KTS 1 - Fine (jemný)



Kód	balenie	m. j.	pal.
48120	210 L	ks	20

frakcia: 0 - 5 mm, výsev

KTS 2 - Fine (jemný)



KLASMANN **K** DEILMANN
we make it grow

Kód	balenie	m. j.	pal.
48270	210 L	ks	20

frakcia: 0 - 5 mm, priesady

KTS 2 - Standard



Kód	balenie	m. j.	pal.
48220	210 L	ks	20

frakcia: 0 - 25 mm

KTS 3 - Standard + íl



Kód	balenie	m. j.	pal.
48320	210 L	ks	20

frakcia: 0 - 25 mm

Rašelina frézovaná



Kyslá pH 3,5 - 4,0

Kód	balenie	m. j.	pal.
7951	250 L	ks	15

Neutrálna pH 5,5 - 6,2

Kód	balenie	m. j.	pal.
7961	250 L	ks	15

Pindstrup Plus Orange



Kód	balenie	m. j.	pal.
2800	300 L	ks	-

frakcia: 0 - 10 mm

Keramzit, Piesok

Keramzit - LIAPOR 8 - 16 mm neupravený



Kód	balenie	m. j.	pal.
60	50 L	ks	36

Keramzit - LIAFLOR 8 - 16 mm upravený lesklý



Kód	balenie	m. j.	pal.
65	50 L	ks	36
6510	10 L	ks	66

Pemza 7 - 14 mm

NEW



Kód	balenie	m. j.	pal.
8054	BB 2 m ²	-	-
8056	50 l	ks	36

Piesok do pieskoviska 0 - 2 mm



Kód	balenie	m. j.	pal.
94014	25 kg	ks	48

Vegetačné strechy

Intenzívny substrát



Kód	balenie	m. j.	pal.
2470	1,7 m ³	ks	1

Drvený liapor (Liadrain), tehlová drvina, rašelina, kompost, Start&Gro 14-16-18 so stopovými prvkami, pH 6,5 - 7,5, EC max. 0,8 mS - hodnoty pH a EC vo vodnom výluhu 1:25

Extenzívny substrát

Florcom



Kód	balenie	m. j.	pal.
2480	1,7 m ³	ks	1

Drvený liapor (Liadrain), pórovité kamenivo, čistá tehlová drvina, bezburinný kompost, triedená borkovaná rašelina, Start&Gro 14 - 16 - 18 so stopovými prvkami, pH (CaCL2) 6,0 - 8,5, EC max. 0,65 mS

Minerálny - mobilná zeleň



Kód	balenie	m. j.	pal.
2462	45 L	ks	45

50% drtený liapor, 50% borkovaná rašelina, frakcia 7 - 20 mm +100 kg zeolitu/m³ štartovacie hnojivo 1,5 kg/m³, pH 5,8 - 6,0

Substrát strešný extenzívny



Kód	balenie	m. j.	pal.
2460	45 L	ks	39

Drtený liapor, tehlová drť, škvára, rašelina, PG mix 14 - 16 - 18 + stopové prvky pH 6,2 - 6,8

Spojka k okrajovému profilu



Kód	m. j.
999117	ks
130/120 x 80 mm	

Kód	m. j.
9991171	ks
130/90 x 60 mm	

Okrajový profil



Kód	m. j.
999116	ks
2000/120 x 80 mm	

Kód	m. j.
9991161	ks
2000/90 x 60 mm	

Rohový profil



Kód	m. j.
999120	ks
500 + 500/120 x 80 mm	

Kód	m. j.
999120	ks
500 + 500/90 x 60 mm	

Kontrolná šachta



Kód	m. j.
999122	ks

šachta na plochu s výškou 100 mm

Drenážna akumulčná rohož

2,102 x 0,98 m



Kód	balenie	m. j.	pal.
999103	2,06 m ²	ks	218

450 m² = 218 ks/pal, výška štupla 4,0 cm, 21,26 l/m²

Drenážna akumulčná rohož

1,91 x 0,96 m



Kód	balenie	m. j.	pal.
999101	1,838 m ²	ks	299

555 m² = 302 ks/pal, výška štupla 2,5 cm, 10 l/m²

Retenčno-vegetačná doska AQUADESK



Kód	m. j.	pal.
9991030	ks	200

1200 x 600 x 20 mm

Je vyrobená z termicky spojených recyklovaných polyesterových vlákien. Oproti klasickému strešnému substrátu vyniká mimo iné hlavne nižšou váhou.



Viacdruhový rozchodníkový koberec



Kód	m. j.
5501	ks

850 x 2400 mm

Je vhodný na extenzívne zelené strechy zložené z odolných druhov ako Sedum lydium, Sedum album, Sedum acre, Sedum sexangulare...

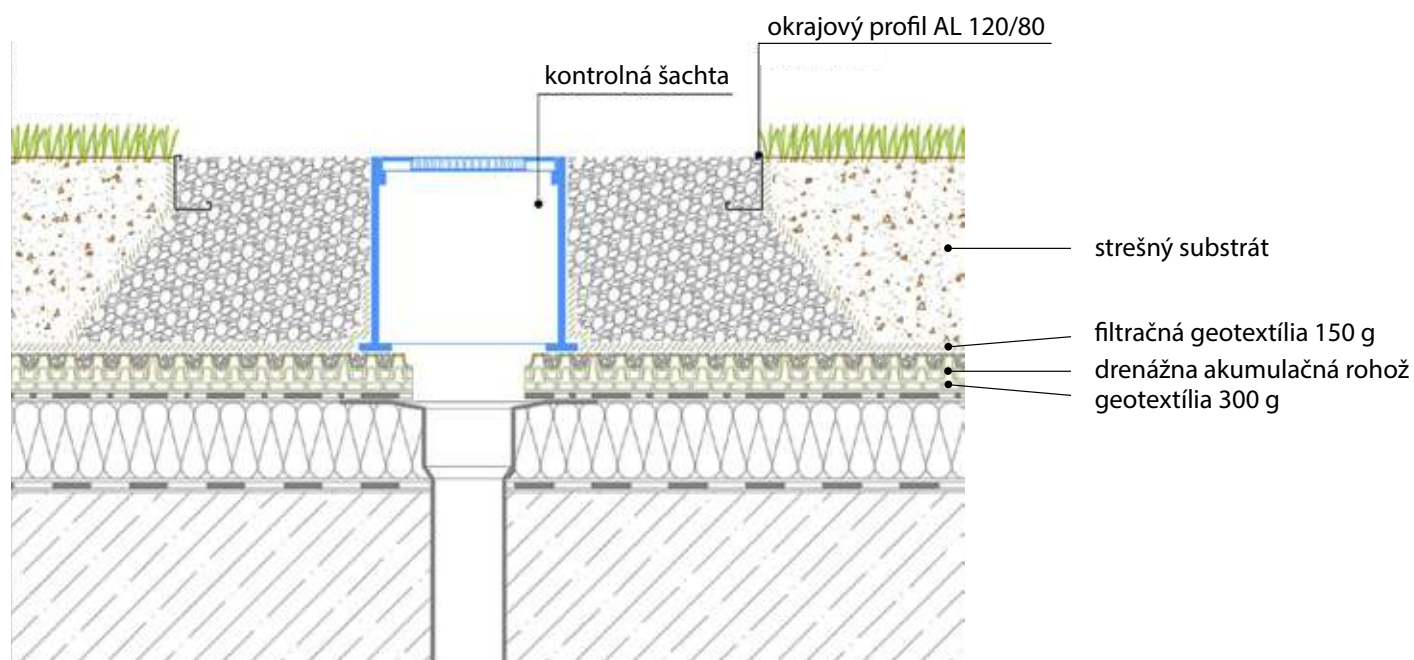

Vertikálne systémy



Vegetačná stena

Modul

(priemer 90 mm)



Kód	farba	m. j.
999202	šedá	ks

1m² - 40 modulov

Modul

(priemer 140 mm)



Kód	farba	m. j.
999201	čierna	ks
999200	šedá	ks

1m² - 18 modulov

Membránové čerpadlo

12V - 5,5 l/min - 5,5 bar



Kód	m. j.
999300	ks

Tlaková nádoba

0,75 l



Kód	m. j.
999310	ks

Zapojenie závlahy

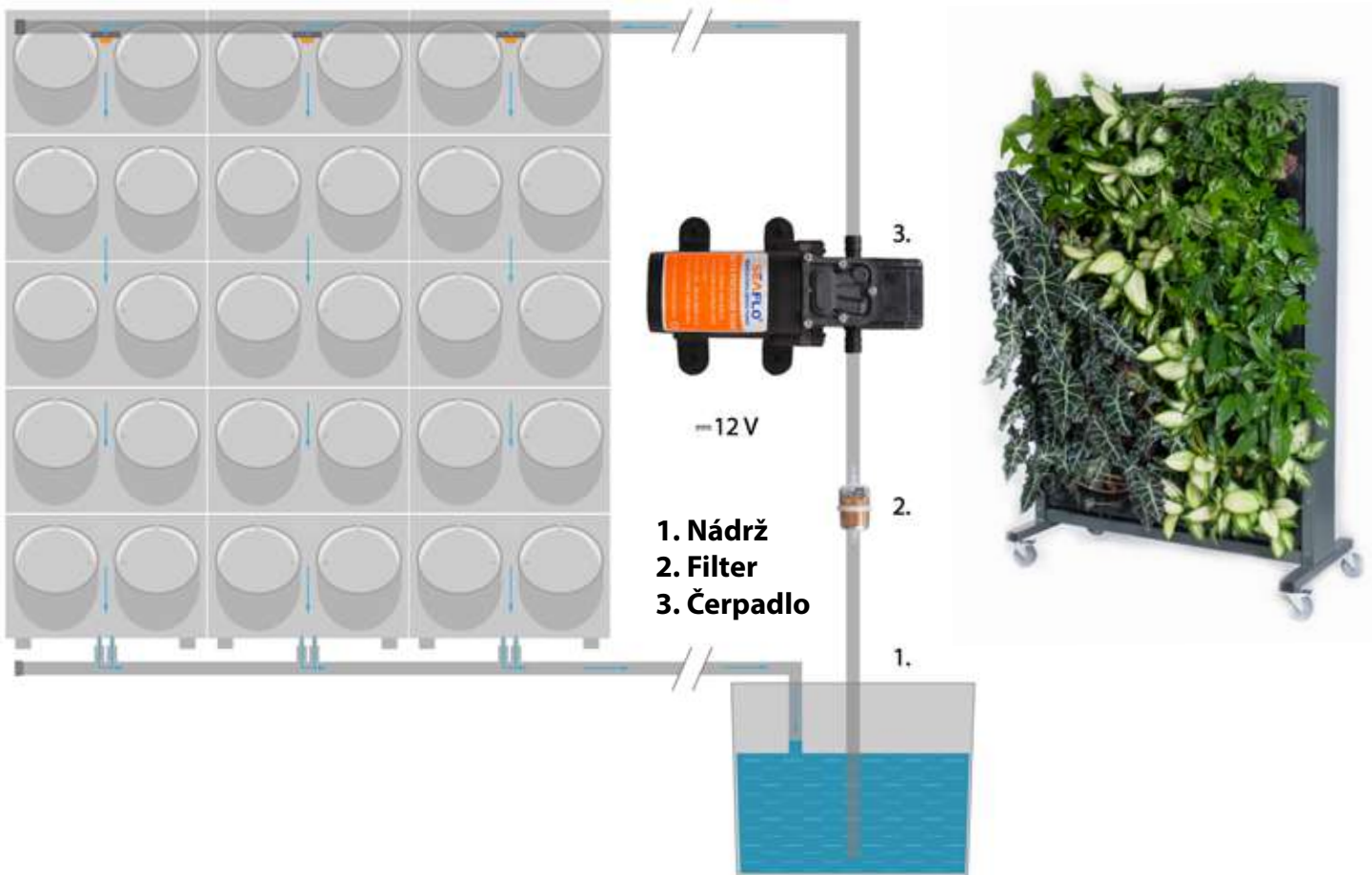

Rozmery modulu

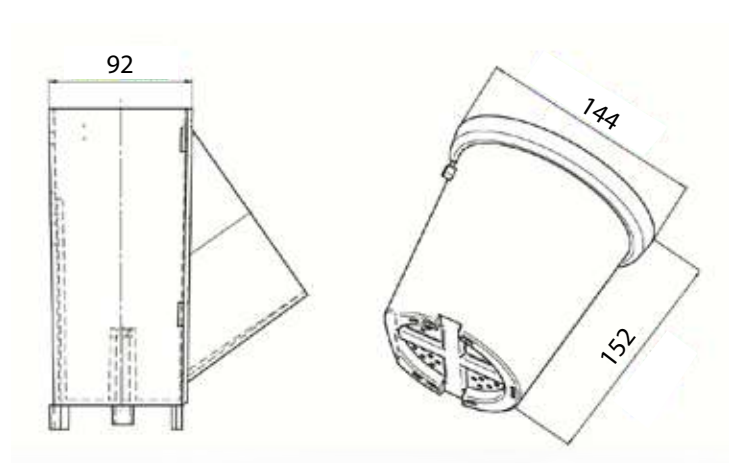
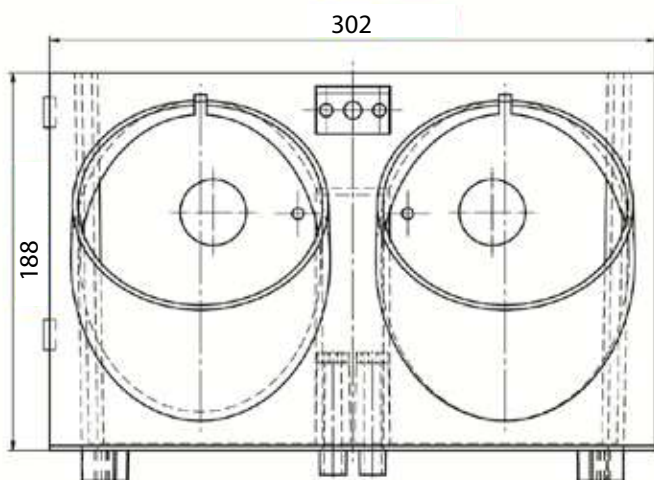

materiál	množstvo	hmotnosť	objem vody
PP PE	18/m ²	0,7 kg	0,7 l

Mulčovacia kôra

Borovicová na trvalky

NEW



Kód	frakcia	balenie	m. j.	pal.
53752	0 - 10 mm	70 l	ks	39

Borovicová triedená



Kód	frakcia	balenie	m. j.	pal.
5370	0 - 40 mm	70 l	ks	39
5375	0 - 60 mm	70 l	ks	39

Borovicová PREMIUM

NEW



Kód	frakcia	balenie	m. j.	pal.
53751	20 - 80 mm	70 l	ks	39

Smreková

Florcom



Kód	balenie	m. j.	pal.
5300	70 l	ks	39

Štiepky



Kód	farba	balenie	m. j.	pal.
53140	oranžová	60 l	ks	39



Kód	farba	balenie	m. j.	pal.
53130	červená	60 l	ks	39



Kód	farba	balenie	m. j.	pal.
53120	hnedá	60 l	ks	39



Kód	farba	balenie	m. j.	pal.
53110	žltá	60 l	ks	39

Píniová kôra Premium Quality



Kód	frakcia	balenie	m. j.	pal.
4015	8 - 15 mm	70 l	ks	42



Kód	frakcia	balenie	m. j.	pal.
41525	15 - 25 mm	70 l	ks	39



Kód	frakcia	balenie	m. j.	pal.
42540	25 - 40 mm	70 l	ks	39



Kód	frakcia	balenie	m. j.	pal.
44060	40 - 60 mm	70 l	ks	39



Kód	frakcia	balenie	m. j.	pal.
460100	60 - 100 mm	70 l	ks	39



Píniová kôra prémiovej kvality. Možno použiť vo všetkých typoch záhrad.

Landscaper Pro



Full Season



Kód	balenie	m. j.	pal.
70514	15 kg	ks	66

27+05+05+2MgO/8-9M

Shade Special



Kód	balenie	m. j.	pal.
70522	15 kg	ks	66

11+05+05+8Fe

Maintenance



Kód	balenie	m. j.	pal.
70504	15 kg	ks	66

25+05+12/2-3M

All Round



Kód	balenie	m. j.	pal.
70502	15 kg	ks	66

24+05+08+2MgO/4-5M

Spring & Summer



Kód	balenie	m. j.	pal.
70496	15 kg	ks	66

20+00+07+6CaO+3MgO/2-3M

New Grass



Kód	balenie	m. j.	pal.
70500	15 kg	ks	66

20+20+08/3M

Stress Control



Kód	balenie	m. j.	pal.
70510	15 kg	ks	66

16+05+22/2-3M

Autumn & Winter



Kód	balenie	m. j.	pal.
70498	15 kg	ks	66

12+05+20+5CaO+2MgO/2-3M

Pre Winter



Kód	balenie	m. j.	pal.
70506	15 kg	ks	66

14+05+21+2MgO/4-5M

Flora



Kód	balenie	m. j.	pal.
70512	15 kg	ks	66

15+09+11+3MgO/5-6M



LSP Spring & Summer



Kód	balenie	m. j.	pal.
41330105	5 kg	ks	120

20-0-7+6CaO+3MgO/2-3M

LSP New Grass



Kód	balenie	m. j.	pal.
41930105	5 kg	ks	120

20-20-8/3M

LSP All Round



Kód	balenie	m. j.	pal.
41980105	5 kg	ks	120

24-5-8+2MgO/4-5M

LSP Pre-Winter



Kód	balenie	m. j.	pal.
42420105	5 kg	ks	120

14-5-21+2MgO/4-5M

Sportmaster CRF Mini

Active



Kód	balenie	m. j.	pal.
70751	25 kg	ks	50

15-5-15+4CaO+2MgO

Start



Kód	balenie	m. j.	pal.
70759	25 kg	ks	50

19-19-5+2MgO+TE

Stress Control



Kód	balenie	m. j.	pal.
70755	25 kg	ks	50

10-5-21+4CaO+2MgO

High N



Kód	balenie	m. j.	pal.
70757	25 kg	ks	50

24-5-11

HNOJIVÁ

ProTurf, Compo, Yara Mila

ProTurf



Kód	balenie	m. j.	pal.
70557	25 kg	ks	50

12+05+20+2CaO+2MgO/2M

ProTurf



Kód	balenie	m. j.	pal.
70556	25 kg	ks	50

15+05+15+2CaO+2MgO/2M

ProTurf



Kód	balenie	m. j.	pal.
70555	25 kg	ks	50

21+05+06+2,5CaO+2,5MgO/2M

NovaTec Classic



Kód	balenie	m. j.	pal.
76020	25 kg	ks	42

12-8-16+3MgO+TE/1,5M

NovaTec N-Max



Kód	balenie	m. j.	pal.
76010	25 kg	ks	42

24-5-5+2MgO+TE/1,5M

NovaTec Premium



Kód	balenie	m. j.	pal.
76025	25 kg	ks	42

15-3-20+3MgO+TE

Agrosil LR pôdny kondicionér



Kód	balenie	m. j.	pal.
76750	25 kg	ks	50

1-10-0+45Silikáty (SiO₂)

Yara Mila Complex NPK



Kód	balenie	m. j.	pal.
73200	25 kg	ks	-

12-11-18 (3MgO-8S-Fe-B-Mn-mikro)

Organické hnojivá

Kravský hnoj Marha-Jó



Kód	balenie	m. j.	pal.
118	4 kg	ks	138

Kód	balenie	m. j.	pal.
1150	25 kg	ks	60

Proti burine 3 kg



Kód	balenie	m. j.	pal.
76641	3 kg	ks	240

15+5+5

Proti burine 7,5 kg



Kód	balenie	m. j.	pal.
76645	7,5 kg	ks	64

15+5+5



Proti machu 3 kg



Kód	balenie	m. j.	pal.
76651	3 kg	ks	240

10+5+5+Fe

Proti machu 7,5 kg



Kód	balenie	m. j.	pal.
76655	7,5 kg	ks	64

10+5+5+Fe

S dlhodobým účinkom 3 kg



Kód	balenie	m. j.	pal.
76661	3 kg	ks	240

14,8+5+5+5,5

S dlhodobým účinkom 7,5 kg



Kód	balenie	m. j.	pal.
76665	7,5 kg	ks	64

14,8+5+5+5,5

Trávníkové hnojivá

Jar - leto



Kód	balenie	výdatnosť	m. j.	pal.
69855	5 kg	200 m ²	ks	150
69860	10 kg	400 m ²	ks	100

20-8-8+3MgO+4S



Kód	balenie	výdatnosť	m. j.	pal.
70123	5 kg	200 m ²	ks	160
70121	25 kg	1000 m ²	ks	40

15-5-5+14S+2MgO+0,5Fe



Kód	balenie	výdatnosť	m. j.	pal.
69882	25 kg	800 m ²	ks	48

20-7-10+2MgO+4S

Jeseň



Kód	balenie	výdatnosť	m. j.	pal.
69890	5 kg	200 m ²	ks	150
69892	10 kg	400 m ²	ks	100
69894	20 kg	800 m ²	ks	50

14-10-20+10SO3



Kód	balenie	výdatnosť	m. j.	pal.
70113	5 kg	200 m ²	ks	200
70112	10 kg vedro	400 m ²	ks	52

10-0-25 + 0,5MgO+13S

NEW

Rotačné

Handy Pro ručný



Kód	objem	m. j.
70560	2 l	ks

Easy Green



Kód	objem	rozptyl	m. j.
70562	12 l	1,2 - 3,4 m	ks

Accu Pro One



Kód	objem	m. j.
692199	20 kg	ks

SR2000



Kód	objem	m. j.
70569	42 l	ks

A ccu Pro 2000



Kód	objem	rozptyl	m. j.
70567	22 kg	2 - 6 m	ks



Štrbinové

Classic Drop Spreader



Kód	objem	rozptyl	m. j.
70566	30 l	0,55 m	ks

SS-2



Kód	objem	m. j.
70571	46 l	ks



Nova Calcium



Kód	balenie	m. j.	pal.
24870325	25 kg	ks	48

15.5-0-0+26.5CaO

Nova MagN



Kód	balenie	m. j.	pal.
28550325	25 kg	ks	48

11-0-0+15.5MgO



Nova MagPhos



Kód	balenie	m. j.	pal.
28500325	25 kg	ks	48

0-55-18+7MgO

Nova Pekacid



Kód	balenie	m. j.	pal.
28560325	25 kg	ks	48

0-60-20

Nova Peak



Kód	balenie	m. j.	pal.
28510325	25 kg	ks	48

0-52-34

Nova MagS



Kód	balenie	m. j.	pal.
28570325	25 kg	ks	48

0-0-0+16MgO+32SO3

Nova MAP



Kód	balenie	m. j.	pal.
28520325	25 kg	ks	48

12-61-0

Nova N-K



Kód	balenie	m. j.	pal.
28580325	25 kg	ks	48

13.5-0-46

Nova Ferti-K



Kód	balenie	m. j.	pal.
28530325	25 kg	ks	48

0-0-61

Nova SOP



Kód	balenie	m. j.	pal.
28600325	25 kg	ks	48

0-0-50+46SO3

Nova Quick-Mg



Kód	balenie	m. j.	pal.
28540325	25 kg	ks	48

0-0-15+13MgO



Listové hnojivá

Agroleaf Power High P



Kód	balenie	m. j.	pal.
20940312	2 kg	ks	72

12-52-5+TE

Agroleaf Power Total



Kód	balenie	m. j.	pal.
20960312	2 kg	ks	72

20-20-20+TE

Agroleaf High N



Kód	balenie	m. j.	pal.
20950312	2 kg	ks	72

31-11-11+TE

Agroleaf Power High K



Kód	balenie	m. j.	pal.
20970312	2 kg	ks	72

15-10-31+TE

Osmocote - granulované s riadeným uvoľňovaním - 2. generácia

PRO 12-14M



Kód	balenie	m. j.	pal.
706468	25 kg	ks	50

18+09+10+2MgO+TE

PRO 8-9M



Kód	balenie	m. j.	pal.
706467	25 kg	ks	50

18+9+10+2MgO+TE

PRO 5-6M



Kód	balenie	m. j.	pal.
706466	25 kg	ks	50

19+9+10+2MgO+TE

PRO 3-4M



Kód	balenie	m. j.	pal.
706465	25 kg	ks	50

19+9+10+2MgO+TE

Osmocote Špeciál

OSMOCOTE Bloom



Kód	balenie	m. j.	pal.
70652	25 kg	ks	50

12+07+18+TE/2-3M

OSMOCOTE Topdress



Kód	balenie	m. j.	pal.
70656	25 kg	ks	50

22+05+06+2MgO+TE/4-5M

Osmocote - granulované s riadeným uvoľňovaním - 3. generácia

OSMOCOTE Start



Kód	balenie	m. j.	pal.
70654	25 kg	ks	50

11-11-17+2MgO+TE/06w

OsmoTop



Kód	balenie	m. j.	pal.
70780	25 kg	ks	40

22+05+10+2MgO+TE/2-3M



OSMOCOTE Exact High K



Kód	balenie	m. j.	pal.
706080	25 kg	ks	50

12-07-19+TE/03-04M

OSMOCOTE Exact High K



Kód	balenie	m. j.	pal.
70612	25 kg	ks	50

11-11-18+TE/05-06M

OSMOCOTE Exact High K



Kód	balenie	m. j.	pal.
70614	25 kg	ks	50

11-11-18+TE/08-09M

OSMOCOTE Exact Standard



Kód	balenie	m. j.	pal.
70620	25 kg	ks	50

16-09-12+2MgO+TE/03-04M

OSMOCOTE Exact Standard



Kód	balenie	m. j.	pal.
70622	25 kg	ks	50

15-09-12+2MgO+TE/05-06M

OSMOCOTE Exact Standard



Kód	balenie	m. j.	pal.
70624	25 kg	ks	50

15-09-11+2MgO+TE/08-09M

Dávkovače hnojiva

LEN NA
OBJEDNÁVKU

Kód popis

583503 DOSATRON - do 3 m²/hod**5835081** DOSATRON - do 9 m²/hod

Kód popis

583501 MIXTRON - do 3 m²/hod

Kód popis

583500 Mix Rite - do 25 m²/hod

Exact DCT Protect



Kód	balenie	m. j.	pal.
70606	25 kg	ks	50

14+08+11+2MgO+TE/8-9M

Exact DCT Protect



Kód	balenie	m. j.	pal.
70604	25 kg	ks	50

14+08+11+2MgO+TE/5-6M

Exact DCT Protect



Kód	balenie	m. j.	pal.
70608	25 kg	ks	50

14+08+11+2MgO+TE/12-14M

Exact DCT Hi End



Kód	balenie	m. j.	pal.
70602	25 kg	ks	50

15+09+11+2MgO+TE/8-9M

Exact DCT Hi End



Kód	balenie	m. j.	pal.
70600	25 kg	ks	50

15+09+12+2MgO+TE/5-6M

Exact DCT Hi.End Exact DCT Hi End



Kód	balenie	m. j.	pal.
70603	25 kg	ks	50

15+08+11+2MgO+TE/12-14M

Exact DCT High K



Kód	balenie	m. j.	pal.
706081	25 kg	ks	50

12+07+19+TE/5-6M

Exact DCT High K



Kód	balenie	m. j.	pal.
706082	25 kg	ks	50

12+07+19+TE/8-9M

Exact DCT High K



Kód	balenie	m. j.	pal.
706083	25 kg	ks	50

12+07+19+TE/12-14M



Osmocote - granulované s riadeným uvoľňovaním - 5. generácia

OSMOCOTE 5 S-Curved



Kód	balenie	m. j.	pal.
88760225	25 kg	ks	50

16-08-12+2,2MgO+TE/05-06M

OSMOCOTE 5 S-Curved



Kód	balenie	m. j.	pal.
88770225	25 kg	ks	50

16-08-12+2,2MgO+TE/08-09M



Universol - kryštalické - vodorozpuštné

Violet



Kód	balenie	m. j.	pal.
70754	25 kg	ks	48

10+10+30+3,3MgO+TE

Yellow



Kód	balenie	m. j.	pal.
70752	25 kg	ks	48

12+30+12+2,2MgO+TE

Blue



Kód	balenie	m. j.	pal.
70756	25 kg	ks	48

18+11+18+2,5MgO+TE

Green



Kód	balenie	m. j.	pal.
70750	25 kg	ks	48

23+06+10+2,7MgO+TE

Orange



Kód	balenie	m. j.	pal.
70758	25 kg	ks	48

16+05+25+3,4MgO+TE

Basis



Kód	balenie	m. j.	pal.
70760	25 kg	ks	48

04+19+35+4,1MgO+TE

Hard Water 225



Kód	balenie	m. j.	pal.
70766	25 kg	ks	48

11+10+28+2MgO+TE

Hard Water 211



Kód	balenie	m. j.	pal.
70764	25 kg	ks	48

23-10-10+2MgO+TE

Na kvety s guánom



Kód	balenie	m. j.	pal.
76400	1 l	ks	576

7+5+6 12ks/kartón

Na muškáty



Kód	balenie	m. j.	pal.
76410	1 l	ks	576

8+3+5 12ks/kartón



Na zelené rastliny



Kód	balenie	m. j.	pal.
76435	0,5 l	ks	900

8+5+6 12ks/kartón

Horká soľ



Kód	balenie	m. j.	pal.
84748	1 l	ks	-
84742	1 kg	ks	-
84744	3 kg	ks	-
76590	2,5 kg	ks	320
73180	25 kg	ks	-

(MgSO₄) 16+13% 8ks/kartón

Na citrusy



Kód	balenie	m. j.	pal.
76470	0,5 l	ks	900

8+5+7 12ks/kartón

Na orchideje



Kód	balenie	m. j.	pal.
76491	500 ml	ks	900

4+4+7 12ks/kartón

Hnojivo kryštálické Florfit Premium

Izbové rastliny



Kód	balenie	m. j.	kart.
76680	500 g	ks	5 ks

Balkónové rastliny



Kód	balenie	m. j.	kart.
76682	500 g	ks	5 ks

Plod a kvet



Kód	balenie	m. j.	kart.
76686	500 g	ks	5 ks

Zelenina



Kód	balenie	m. j.	kart.
76684	500 g	ks	5 ks

Na jahody, bobuľoviny



Kód	balenie	m. j.	pal.
76530	1 kg	ks	486

7+8+12+3 6ks/kartón

Na rododendrony
s guánom

Kód	balenie	m. j.	pal.
76560	1 kg	ks	486

12+6+8+2+1 6ks/kartón

Na ruže s guánom



Kód	balenie	m. j.	pal.
76570	1 kg	ks	486

8+8+13+2+1 6ks/kartón

Hnojivo na hortenzie



Kód	balenie	m. j.	pal.
76532	1 kg	ks	486

Bopon

Na okrasné rastliny univerzálne



Kód	balenie	m. j.
B1042	1 kg	ks

NPK 10:5:10
Mg 5% S27% + Micro

Hnojivo na čučoriedky



Kód	balenie	m. j.
B1130	1 kg	ks

NPK 5-5-14
Ca 2% Mg 5% S27%

Hnojivo na hortenzie



Kód	balenie	m. j.
B1127	1 kg	ks

Hnojivo na ihličnany



Kód	balenie	m. j.
B1052	1 kg	ks

Bopon komposter - urýchľovač kompostu



Kód	balenie	m. j.	kart.
B1126	1 kg	ks	12

Antimuscus proti machu



Kód	balenie	m. j.
80324	5 kg	ks
80325	1 kg	ks

Bopon hnojivo

Hnojivo na paradajky, korenie, plod. zeleninu



Kód	balenie	m. j.
B1174	1 kg	ks

Jesenné hnojivo univerzálne



Kód	balenie	m. j.
B1076	1 kg	ks

N 3,5% P 10% K 20%
Ca 8% S 4,8%

Jesenné hnojivo na ihličnany



Kód	balenie	m. j.
B1078	1 kg	ks

P 10% K 20%
Mg 4,5% S 10%

Záhradnícke vápno



Kód	balenie	m. j.
B1164	1 kg	ks

Hnojivo na Juky, Draceny, Palmy



Kód	balenie	m. j.
B1037	500 ml	ks

Na rododendróny a azalky 0,5l



Kód	balenie	m. j.
B1165	500 ml	ks

Hnojivo na previslé surfinie a petúnie



Kód	balenie	m. j.
B1017	500 ml	ks

Hnojivo na muškáty, pelargónie



Kód	balenie	m. j.
B1015	1 l	ks

Hnojivo na ihličnany



Kód	balenie	m. j.
B1024	1 l	ks

Hnojivo na kvitnúce rastliny



Kód	balenie	m. j.
B1009	1 l	ks

Na hortenzie - GÉL



Kód	balenie	m. j.
B1268	500 ml	ks

Na bylinky - GÉL



Kód	balenie	m. j.
B1305	250 ml	ks

Lesk na listy



Kód	balenie	m. j.
B082	250 ml	ks

NPK 15-10-10



Kód	balenie	m. j.
70003	5 kg	ks
70001	25 kg	ks

NPK 15-10-10

Liadok amónny
s dolomitom 27% N

NEW



Kód	balenie	m. j.	pal.
70183	5 kg	ks	200
70186	25 kg	ks	40

Močovina 46% N

NEW



Kód	balenie	m. j.
70152	25 kg	ks
70154	5 kg	ks

46% dusíka, bired max 0,6%

Cererit NPK 8-13-11+ME

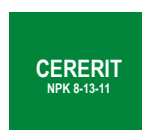

Kód	balenie	m. j.
70063	5 kg	ks
70060	25 kg	ks

Draselná soľ granulát 60% KCl



Kód	balenie	m. j.
70191	25 kg	ks

obsah draslíka 60 %

Síran draselný prášok

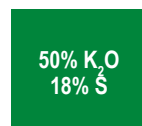

Kód	balenie	m. j.
74650	25 kg	ks

Ducanit dusičnan vápenatý



Kód	balenie	m. j.	pal.
74310	25 kg	ks	48

15,5% N 26,3% CaO

Dusíkaté vápno



Kód	balenie	m. j.
70012	1 kg	ks
70013	2,5 kg	ks
7001400	20 kg	ks

vápno 50%, dusík 20%

YARA hnojivo

Yara Krista-K Plus dusičnan draselný



Kód	balenie	m. j.
72200	2 kg	ks

46% K₂O 13,5% NO₃

YarLiva Calcinit dusičnan vápenatý



Kód	balenie	m. j.
72300	2 kg	ks

15,5%N 19%Ca

YaraVita Tenso Coctail



Kód	balenie	m. j.
74700	1 kg	ks

B,Ca,Cu,Fe,Mn,Mo,Zn

HNOJIVÁ

Kemira - vodorozpustné kryštalické

Ferticare I



Kód	balenie	m. j.	kart.
71000	2 kg	ks	7

14-11-25+ME

Ferticare II



Kód	balenie	m. j.	kart.
71100	2 kg	ks	6

24-8-16+ME

Ferticare III



Kód	balenie	m. j.	kart.
71200	2 kg	ks	7

10-5-26+ME

Ferticare Starter



Kód	balenie	m. j.	kart.
71500	2 kg	ks	7

15-30-15+ME

Engo - vodorozpustné kryštalické

Na kvitnúce rastliny



Kód	balenie	m. j.
70400	500 g	ks

15+11+29

Na izbové rastliny



Kód	balenie	m. j.
70401	500 g	ks

20+10+20

Na úpravu tvrdej vody a dokvitanie



Kód	balenie	m. j.
70402	500 g	ks

18+10+18

Na previslé petúnie



Kód	balenie	m. j.
70404	500 g	ks

20+20+20+Fe

Na dreviny a kríky



Kód	balenie	m. j.
70406	1000 g	ks

Prowen Winners - 5-6M na záhony



Kód	balenie	m. j.
70407	500 g	ks

Na kvety



Kód	balenie	m. j.
70900	100 g	ks
70910	500 g	ks

Na kvety



Kód	balenie	m. j.
70920	2 kg	ks

Na trávnik



Jar - Leto

Kód	balenie	m. j.
70965	0,95 l	ks

8-3-10+3MgO

Na trávnik - náplň



Jar - Leto

Kód	balenie	m. j.
70966	0,95 l	ks

Ostatné hnojivá

Ferrovit



Kód	balenie	m. j.
81710	1 l	ks
81715	5 l	ks
81720	10 l	ks

Harmavit špeciál



Kód	balenie	m. j.
82209	0,5 l	ks
82210	1 l	ks
82211	5 l	ks
82212	10 l	ks

Síra SK 520



Kód	balenie	m. j.
81706	1 l	ks

Fetrilon 13% Fe chelátové železo



Kód	balenie	m. j.
76710	1 kg	ks

ALLIVIT - Práškové hnojivo na cibuľoviny



Kód	balenie	m. j.
82220	0,5 kg	ks

AGRICALMAG



Kód	balenie	m. j.
82215	1 l	ks

CaO 8,5% + MgO 1% + N 5% + bór

Darina 4M



Kód	balenie	m. j.
81183	0,5 l	ks
81182	1 l	ks

Zelená skalica

odstránenie machu v trávniku



Kód	balenie	m. j.
84730	1 kg	ks

Modrá skalica

obsah medi - min. 23%



Kód	balenie	m. j.
84740	0,5 kg	ks

Sport

**Zloženie:**

10 % Kostrava červená trstnatá CASANOVA,
10 % Lipnica lúčna GEISHA,
40 % Mätonoh trváci DOUBLE,
5 % Kostrava ovčia RIDU,
35 % Kostrava červená MAXIMA 1.

Kód	balenie	m. j.
990200	1 kg	ks
990210	7,5 kg	ks
990212	20 kg	ks

Ornamental

**Zloženie:**

10 % Mätonoh trváci DOUBLE,
50 % Kostrava trstovníkovitá STARLETT,
30 % Kostrava červená MAXIMA 1,
10 % Lipnica lúčna GEISHA.

Kód	balenie	m. j.
990300	1 kg	ks
990310	7,5 kg	ks
990311	20 kg	ks

Shadow

**Zloženie:**

15 % Kostrava červená krátkovýbežkatá Archibal/GREENLIGHT,
50 % Kostrava červená MAXIMA 1,
5 % Kostrava ovčia RIDU,
25 % Mätonoh trváci DOUBLE,
5 % Lipnica pospolitá DASAS.

Kód	balenie	m. j.
990420	1 kg	ks
990430	7,5 kg	ks

Waterless

**Zloženie:**

80 % Kostrava trstovníkovitá EYECANDY,
10 % Lipnica lúčna GEISHA,
10 % Mätonoh trváci DOUBLE.

Kód	balenie	m. j.
990400	1 kg	ks
990410	7,5 kg	ks
990412	20 kg	ks

Eco Lawn

**Zloženie:**

35 % Mätonoh trváci DOUBLE,
5 % Lipnica lúčna GEISHA,
12 % Kostrava červená krátkovýbežkatá PINAFORE,
45 % Kostrava červená MAXIMA 1,
3 % MicroClover Ďatelina plazivá.

Kód	balenie	m. j.
990500	1 kg	ks
990510	7,5 kg	ks

Mini

**Zloženie:**

10 % Lipnica lúčna GEISHA,
30 % Kostrava červená MAXIMA 1,
20 % Kostrava červená trstnatá CASANOVA,
20 % Kostrava ovčia RIDU,
20 % Mätonoh trváci DOUBLE.

Kód	balenie	m. j.
990450	1 kg	ks
990454	20 kg	ks
990460	7,5 kg	ks

Sportmaster C&T



Kód	balenie	m. j.
990570	10 kg	ks

Grass Fix

**Zloženie:**

60 % Mätonoh trváci DOUBLE,
30 % Kostrava červená MAXIMA 1,
10 % Lipnica lúčna GEISHA.

Kód	balenie	m. j.
990550	1 kg	ks
990560	7,5 kg	ks

SportProfi**Zloženie:**

20 % Lipnica lúčna CONNI,
20 % Lipnica lúčna JULIUS,
20 % Lipnica lúčna GEISHA, YVETTE,
20 % Mätonoh trváci DOUBLE,
10 % Mätonoh trváci MONROE,
10 % Mätonoh trváci DUPARC.

Kód	balenie	m. j.
990601	20 kg	ks

Universal**Zloženie:**

10 % Lipnica lúčna BALIN, EVORA,
30 % Mätonoh trváci BELIDA,
20 % Mätonoh trváci ESQUIRE,
20 % Kostrava červená dl. výbežkatá
MAXIMA 1,
20 % Mätonoh trváci DOUBLE.

Kód	balenie	m. j.
990611	20 kg	ks

**NDS R1 technická zmes****Zloženie:**

15 % Mätonoh trváci,
55 % Kostrava červená,
15 % Kostrava ovčia,
15 % Lipnica lúčna.

Kód	balenie	m. j.
990631	20 kg	ks

Park**Zloženie:**

10 % Lipnica lúčna BALIN, EVORA,
30 % Mätonoh trváci ESQUIRE,
35 % Kostrava červená dl. výbežkatá
MAXIMA 1,
25 % Kostrava červená trsnatá FIDELIO.

Kód	balenie	m. j.
990635	20 kg	ks

Dosev a regenerácia**Zloženie:**

20 % Mätonoh trváci GREENWAY,
30 % Mätonoh trváci DOUBLE,
30 % Mätonoh trváci ESQUIRE,
20 % Mätonoh trváci DUPARC.

Kód	balenie	m. j.
990639	20 kg	ks

Watersaver



Kód	balenie	m. j.
149021	5 kg	ks
149010	15 kg	ks

Mow saver



Kód	balenie	m. j.
149160	5 kg	ks

Bar Power RPR



Kód	balenie	m. j.
149060	15 kg	ks
149070	5 kg	ks

SuperSport



Kód	balenie	m. j.
14912	5 kg	ks

ProSoil



Kód	balenie	m. j.
14934	5 kg	ks

Super Overseeding (SOS)



Kód	balenie	m. j.
149330	5 kg	ks

Shadow



Kód	balenie	m. j.
149280	5 kg	ks

Rapid



Kód	balenie	m. j.
149290	5 kg	ks



Kvitnúca lúka Blumenwiese

Kód	balenie	m. j.
9906800	10 kg	ks

Výdatnosť 600 - 800 m²**Zloženie:**

25% Mätonoh trváci (*Lolium perenne*), 24% Kostrava červená dlhovýbežkatá (*Festuca rubra rubra*), 15% Kostrava červená trsnatá (*Festuca rubra commutata*), 10% Kostrava ovčia (*Festuca ovina*), 15% Lipnica lúčna (*Poa pratensis*), 5% leguminózy, 1% Ďatelina lúčna (*Trifolium pratense*), 5% kvitnúce jednorôčné a trvácne byliny: *Achillea millefolium*, *Anthemis tinctoria*, *Aquelegia vulgaris*, *Bellis perennis*, *Calendula officinalis*, *Campanula carpatica*, *Campanula glomerata*, *Campanula rotundifolia*, *Centaurea cyanus*, *Centaurea scabiosa*, *Chrysanthemum carinatum*, *Chrysanthemum coro.*, *Chrysanthemum segefum*, *Coreopsis tinctoria*, *Daucus carota*, *Dianthus carthusianorum*, *Dianthus deltoides*, *Digitalis purpurea*, *Eschscholzia californica*, *Galium mollugo*, *Galium verum*, *Hypericum perforatum*, *Knautia arvensis*, *Leucanthemum vulgare*, *Linum grandiflorum rubrum*, *Lynchis mollugo*, *Galium verum*, *Hypericum perforatum*, *Knautia arvensis*, *Leucanthemum vulgare*, *Linum grandiflorum rubrum*, *Lynchis flos cuculi*, *Nigella sativa*, *Papaver rhoeas*, *Pimpinella saxifraga*, *Plantago lanceolata*, *Potentilla recta*, *Prunella vulgaris*, *Sanquisorba minor*, *Salvia pratensis* und *Thymus serpyllum*.

Trávobylinná lúka KLASIK

Kód	balenie	m. j.
990690	1 kg	ks

Zloženie:

Trávy 90%: *Agrostis capillaris* 3%, *Agrostis gigantea* 2%, *Anthoxanthum odoratum* 1%, *Arrhenatherum elatior* 5%, *Festuca pratensis* 9%, *Festuca rubra commutata* 10%, *Festuca rubra rubra* 15%, *Festuca rubra trichophylla* 6%, *Festuca trachyphylla* 18%, *Lolium perenne* 2%, *Phleum pratense* 8%, *Poa pratensis* 11%.

Byliny 7,3%: *Agrimonia eupatoria* 0,6%, *Achillea millefolium* 0,3%, *Anthemis tinctoria* 0,5%, *Carum carvi* 0,2%, *Centaurea jacea* 0,4%, *Daucus carota* 0,1%, *Galium album* 0,3%, *Hypericum perforatum* 0,4%, *Leontodon autumnalis* 0,1%, *Leontodon hispidus* 0,1%, *Leucanthemum vulgare* 1,6%, *Malva moschata* 0,4%, *Matricaria chamomilla* 0,2%, *Origanum vulgare* 0,4%, *Papaver rhoeas* 0,2%, *Plantago lanceolata* 0,2%, *Salvia pratensis* 0,8%, *Sanguisorba minor* 0,5%.

Ďatelinovy 2,7%: *Anthyllis vulneraria* 0,5%, *Lotus corniculatus* 0,8%, *Medicago lupulina* 0,2%, *Onobrychis viciifolia* 1%, *Trifolium pratense* 0,2%.

Odporúčaný výsev: 5 - 8 g/m² (1 kg = 125 - 200 m²).**Kvetnatá lúka Naturgarden**

Kód	balenie	m. j.
990695	200 g	ks

Zloženie:

Trávy 92%: *Agrostis gigantea* 4%, *Agrostis capillaris* 1%, *Alopecurus pratensis* 4%, *Cynosurus cristatus* 10%, *Festuca rubra commutata* 12%, *Festuca rubra rubra* 30%, *Festuca rubra trichophylla* 18%, *Lolium perenne* 3%, *Phleum bertolonii* 6%, *Poa pratensis* 4%.

Byliny 7,25%: *Achillea millefolium* 0,05%, *Agrimonia procera* 0,25%, *Anthemis tinctoria* 0,7%, *Carum carvi* 0,15%, *Centaurea jacea* 0,3%, *Daucus carota* 0,1%, *Dianthus carthusianorum* 0,5%, *Galium album* 0,3%, *Hypericum perforatum* 0,3%, *Hyssopus officinalis* 0,2%, *Leontodon autumnalis* 0,1%, *Leucanthemum vulgare* 1,2%, *Linum usitatissimum* 0,2%, *Malva moschata* 0,4%, *Matricaria chamomilla* 0,05%, *Plantago lanceolata* 0,05%, *Potentilla recta* 0,3%, *Salvia pratensis* 1,2%, *Sanquisorba minor* 0,15%, *Silene dioica* 0,3%, *Silene vulgaris* 0,2%, *Silybum marianum* 0,05%.

Letničky 0,35%: *Agrostemma githago* 0,15%, *Calendula officinalis* 0,15%, *Papaver rhoeas* 0,05%.

Lucerna siata C1 ARTEMIS

Kód	balenie	m. j.
149430	500 g	ks

Ďatelina lúčna C1 SPURT/AGIL

Kód	balenie	m. j.
149390	250 g	ks

DLF LOUKA 4 - na seno, pasenie koní, ovčí

Kód	balenie	m. j.
990703	5 kg	ks
990705	10 kg	ks

Pletivo pod trávnik

Pletivo Polynet 301R PE

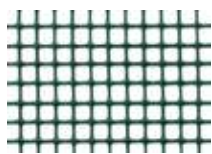

Kód	balenie	m. j.
28710	50 m	ks

zelené/čierne, oká 10 x 10 mm

Pletivo pod trávnik 45 g

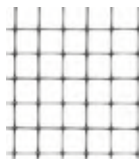

Kód	balenie	m. j.
28755	1x 200 m	ks
28756	2x 200 m	ks
28758	1x 20 m	ks
28759	1x 50 m	ks

čierne, oká 15 x 15 mm

Pletivo pod trávnik 58 g

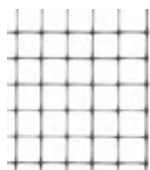

Kód	balenie	m. j.
28721	1x 200 m	ks
28722	2x 200 m	ks

čierne, oká 18 x 18 mm

Krtko - pletivo 44 g

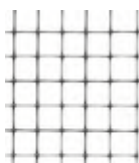

Kód	balenie	m. j.
28751	1x 200 m	ks
28752	2x 200 m	ks

čierne, oká 15 x 15 mm

Okraje trávniku

Obruba zatĺkacia



Kód	farba	rozmery	m. j.
14030	zelená	12 x 15 cm	ks
14031	hnedá	12 x 15 cm	ks

Plastový lem - obruba



Kód	výška	balenie	m. j.
11223344	15 cm	25 m	ks

Okraj trávniku



Kód	výška	dĺžka	m. j.
14010	10 cm	9 m	ks
14015	15 cm	9 m	ks
14020	20 cm	9 m	ks

Nerezový lem



Kód	výška	dĺžka	m. j.
140015	130 mm	1,5 m	ks

Trávníkový lem



Kód	výška	dĺžka	m. j.	balenie
140110	9,5 cm	6 m	ks	12

Záhradný obrubník flex



Kód	výška	dĺžka	m. j.	balenie
150451	3,8 cm	10 m	ks	1

Ekobrim lišta



Kód	výška	m. j.
14001	5 cm	ks

Plastový kliniec Ekobrim



Kód	rozмеры	balenie	m. j.
14003	240 x 16 mm	50 ks	ks

Príchytky na pletivo pod trávnu 10 cm



hlavička 3 cm

Kód	balenie	m. j.
28711	100 ks	bal.
28713	300 ks	bal.
28715	500 ks	bal.

Plastový kliniec k záhradným obrubník



Kód	dĺžka	šírka hlavičky	balenie	m. j.
140035	25 cm	1,5 cm	50 ks	ks
140034	24 cm	3 cm	50 ks	ks

Záhradné obrubníky

GARDEN 45



Kód	výška	dĺžka	šírka	m. j.	balenie
1400450	45 mm	1025 mm	80 mm	ks	800

NÍZKY



Kód	výška	dĺžka	šírka	m. j.	balenie
140045	45 mm	1025 mm	75 mm	ks	728

CORNER

AKCIA



Kód	výška	dĺžka	šírka	m. j.	balenie
1400457	55 mm	1000 mm	140 mm	ks	300

STREDNÝ



Kód	výška	dĺžka	šírka	m. j.	balenie
140058	58 mm	1025 mm	75 mm	ks	952

VYSOKÝ



Kód	výška	dĺžka	šírka	m. j.	balenie
140078	78 mm	1025 mm	75 mm	ks	728



Zatrávňovacie panely

Zatrávňovací panel PUZZLE čierny 0,24 m²

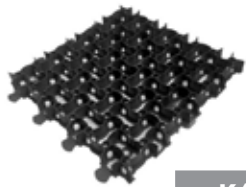

Kód	rozмеры	m. j.
1400459	492 x 492 x 39 mm	ks

Zatrávňovací panel zelený 0,876 m²



Kód	rozмеры	m. j.
14004	1160 x 755 x 38 mm	ks

Stabilizačná rohož na štrk 0,98 m²

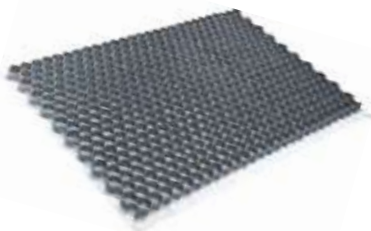

Kód	rozмеры	m. j.	farba
140061	1176 x 764 x 32 mm	ks	šedá
1400610	1176 x 764 x 32 mm	ks	biela

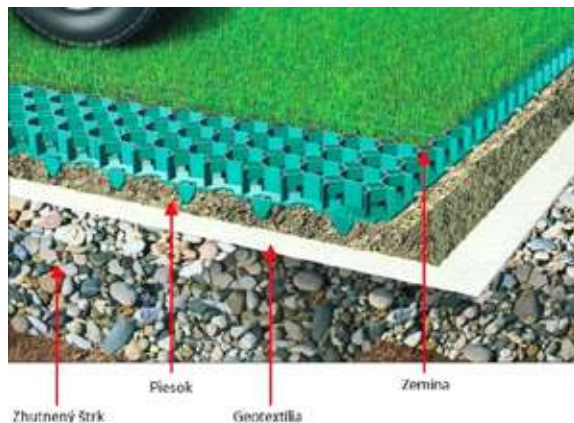

Umelý trávnik

PRIPRAVUJEME NOVÉ TYPY TRÁVNIKOV NA ROK 2024





V našej ponuke nájdete aj širokú škálu moderných dizajnových kvetináčov. Sú vyrobené väčšinou zo sklolaminátu.

V kolekcii nájdete kvetináče v povrchových úpravách:

- Fiberstone
- Ficonstone
- Fiberclay
- Sandstone

Kompletnú ponuku a katalógy dostanete na vyžiadanie v predajni.



Odlahčené kvetináče MODIFORM

Kvetináče



Kód	názov	farba	rozmer	balenie/pal.
1007002167	P085574	Royal grey	8,5 cm 5° M 285 cc	2x 27650 = 55300 ks
1057002133	P09568	Royal grey	9 cm 5° L 300 cc	2x 23400 = 46800 ks
1107002425	P09568	Terakota	9 cm 5° L 300 cc	2x 23400 = 46800 ks
1207002172	P09587	Royal grey	9 cm 5° H 350 cc	2x 22800 = 45600 ks
1307002440	P09587	Terakota	9 cm 5° H 350 cc	2x 22800 = 45600 ks
1407002135	P105579	Royal grey	10,5 cm 5° L 470 cc	2x 16112 = 32224 ks
1507002127	P105579	Terakota	10,5 cm 5° L 470 cc	2x 16112 = 32224 ks
1607002142	P105590	Royal grey	10,5 cm 5° HB 11V 510 cc	2x 15476 = 30952 ks
1707002270	P105590	Terakota	10,5 cm 5° HB 11V 510 cc	2x 15476 = 30952 ks
1807002176	P10576	Royal grey	10 cm 5° 400 cc	2x 18150 = 36300 ks
1907002047	P12589	Royal grey	12 cm 5° L 690 cc	2x 12118 = 24236 ks
2007002633	P12589	Terakota	12 cm 5° L 690 cc	2x 12118 = 24236 ks
2107002141	P12889	Royal grey	12 cm 8° L 650 cc	2x 12118 = 24236 ks
2207002271	P12889	Terakota	12 cm 8° L 650 cc	2x 12118 = 24236 ks
2307002128	P13596	Royal grey	13 cm 5° L 885 cc	2x 9240 = 18480 ks
2407002364	P13596	Terakota	13 cm 5° L 885 cc	2x 9240 = 18480 ks
2507002195	P145109	Royal grey	14 cm 5° L 1100 cc	2x 7440 = 14880 ks
2607002258	P145C121	Terakota	Cont. 14 cm 5° 1300 cc	2x 7440 = 14880 ks
2707002200	P155124	Royal grey	15 cm 5° 1500 cc	2x 5880 = 11760 ks
2807002134	P175128	Royal grey	17 cm 5° L 2000 cc	2x 3978 = 7956 ks
2907002574	P175128	Terakota	17 cm 5° L 2000 cc	2x 3978 = 7956 ks
3007002129	P195149	Royal grey	19 cm 5° L 3000 cc	2x 3072 = 6144 ks
3107002580	P195149	Terakota	19 cm 5° L 3000 cc	2x 3072 = 6144 ks
3207002205	SQ070765-H8	Royal grey	7 x 7 L BX 190 cc	2x 41664 = 83328 ks
3307002207	SQ070780-H8	Royal grey	7 x 7 H BX 228 cc	2x 40320 = 80640 ks
3407002209	SQ080870-H8	Royal grey	8 x 8 L BX 275 cc	2x 20736 = 41472 ks
3507002770	SQ080880-H8	Dark green	8 x 8 H BX 306 cc	2x 20448 = 40896 ks



Kód	farba	rozmer	balenie/pal.
46124001	čierny	7 x 7 x 6,2 cm/200 cc	2016 ks x 40 kartónov = 80640 ks/Hpal
21021101	čierny	7 x 7 x 8 cm PP/230 cc	2160 ks x 40 kartónov = 86400 ks/Hpal
46714001	čierny	8 x 8 x 7cm PN/300 cc	239 ks x 36 kartónov = 44604 ks/Hpal
46774001	čierny	8 x 8 x 8 cm PN/400 cc	1218 ks x 36 kartónov = 43848 ks/Hpal
46884001	čierny	9 x 9 x 8 cm SQ /480 cc	1104 ks x 30 kartónov = 33120 ks/Hpal
46904001	čierny	9 x 9 x 9,5 cm SQ /590 cc	1008 ks x 30 kartónov = 30240 ks/Hpal



Kód	rozmer	farba	balenie/pal.
2208506501	d 8,5 cm/5°/h 6,5 cm/220 cc	čierno-šedý	2150 ks x 18 kart. = 38700 ks/H pal
2208506502	d 8,5 cm/5°/h 6,5 cm/220 cc	terakota	2150 ks x 18 kart. = 38700 ks/H pal
2208506503	d 8,5 cm/5°/h 6,5 cm/220 cc	biely	2150 ks x 18 kart. = 38700 ks/H pal
2208506504	d 8,5 cm/5°/h 6,5 cm/220 cc	šedý NIR	2150 ks x 18 kart. = 38700 ks/H pal
2209006801	d 9,0 cm/5°/h 6,8 cm/300 cc	čierno-šedý	1920 ks x 18 kart. = 34560 ks/H pal
2209006802	d 9,0 cm/5°/h 6,8 cm/300 cc	terakota	1920 ks x 18 kart. = 34560 ks/H pal
2209006803	d 9,0 cm/5°/h 6,8 cm/300 cc	biely	1920 ks x 18 kart. = 34560 ks/H pal
2209006804	d 9,0 cm/5°/h 6,8 cm/300 cc	šedý NIR	1920 ks x 18 kart. = 34560 ks/H pal
2210007601	d 10,0 cm/5°/h 7,6 cm/410 cc	čierno-šedý	1472 ks x 18 kart. = 26496 ks/H pal
2210007602	d 10,0 cm/5°/h 7,6 cm/410 cc	terakota	1472 ks x 18 kart. = 26496 ks/H pal
2210007603	d 10,0 cm/5°/h 7,6 cm/410 cc	biely	1472 ks x 18 kart. = 26496 ks/H pal
2210007604	d 10,0 cm/5°/h 7,6 cm/410 cc	šedý NIR	1472 ks x 18 kart. = 26496 ks/H pal
2210508001	d 10,5 cm/5°/h 8,0 cm/460 cc	čierno-šedý	1395 ks x 18 kart. = 25110 ks/H pal
2210508002	d 10,5 cm/5°/h 8,0 cm/460 cc	terakota	1395 ks x 18 kart. = 25110 ks/H pal
2210508003	d 10,5 cm/5°/h 8,0 cm/460 cc	biely	1395 ks x 18 kart. = 25110 ks/H pal
2210508004	d 10,5 cm/5°/h 8,0 cm/460 cc	šedý NIR	1395 ks x 18 kart. = 25110 ks/H pal
2210509201	d 10,5 cm/5°/h 9,2 cm/510 cc	čierno-šedý	1260 ks x 18 kart. = 22680 ks/H pal
2210509202	d 10,5 cm/5°/h 9,2 cm/510 cc	terakota	1260 ks x 18 kart. = 22680 ks/H pal
2210509203	d 10,5 cm/5°/h 9,2 cm/510 cc	biely	1260 ks x 18 kart. = 22680 ks/H pal
2210509204	d 10,5 cm/5°/h 9,2 cm/510 cc,	šedý NIR	1260 ks x 18 kart. = 22680 ks/H pal
2211008201	d 11,0 cm/5°/h 8,2 cm/500 cc	čierno-šedý	1118 ks x 18 kart. = 20124 ks/H pal
2211008202	d 11,0 cm/5°/h 8,2 cm/500 cc	terakota	1118 ks x 18 kart. = 20124 ks/H pal
2211008203	d 11,0 cm/5°/h 8,2 cm/500 cc	biely	1118 ks x 18 kart. = 20124 ks/H pal
2211008204	d 11,0 cm/5°/h 8,2 cm/500 cc	šedý NIR	1118 ks x 18 kart. = 20124 ks/H pal
2211009801	d 11,0 cm/5°/h 9,8 cm/640 cc	čierno-šedý	988 ks x 18 kart. = 17784 ks/H pal
2211009802	d 11,0 cm/5°/h 9,8 cm/640 cc	terakota	988 ks x 18 kart. = 17784 ks/H pal
2211009803	d 11,0 cm/5°/h 9,8 cm/640 cc	biely	988 ks x 18 kart. = 17784 ks/H pal
2211009804	d 11,0 cm/5°/h 9,8 cm/640 cc	šedý NIR	988 ks x 18 kart. = 17784 ks/H pal
2211709001	d 11,7 cm/5°/h 9,0 cm/660 cc	čierno-šedý	984 ks x 18 kart. = 17712 ks/H pal
2211709002	d 11,7 cm/5°/h 9,0 cm/660 cc	terakota	984 ks x 18 kart. = 17712 ks/H pal
2211709003	d 11,7 cm/5°/h 9,0 cm/660 cc	biely	984 ks x 18 kart. = 17712 ks/H pal
2211709004	d 11,7 cm/5°/h 9,0 cm/660 cc	šedý NIR	984 ks x 18 kart. = 17712 ks/H pal
2211709005	d 11,7 cm/5°/h 9,0 cm/660 cc	VIOLET	984 ks x 18 kart. = 17712 ks/H pal
2211709006	d 11,7 cm/5°/h 9,0 cm/660 cc	GREEN	984 ks x 18 kart. = 17712 ks/H pal
2211709007	d 11,7 cm/5°/h 9,0 cm/660 cc	PINK	984 ks x 18 kart. = 17712 ks/H pal
2212009001	d 12,0 cm/5°/h 9,0 cm/720 cc	čierno-šedý	810 ks x 18 kart. = 14580 ks/H pal



Odlahčené kvetináče Floser

Kvetináče



Kód	rozmer	farba	balenie/pal.
2212009002	d 12,0 cm/5°/h 9,0 cm/720 cc	terakota	810 ks x 18 kart. = 14580 ks/H pal
2212009003	d 12,0 cm/5°/h 9,0 cm/720 cc	biely	810 ks x 18 kart. = 14580 ks/H pal
2212009004	d 12,0 cm/5°/h 9,0 cm/720 cc	šedý NIR	810 ks x 18 kart. = 14580 ks/H pal
2213009801	d 13,0 cm/5°/h 9,8 cm/850 cc	čierno-šedý	612 ks x 18 kart. = 11016 ks/H pal
2213009802	d 13,0 cm/5°/h 9,8 cm/850 cc	terakota	612 ks x 18 kart. = 11016 ks/H pal
2213009803	d 13,0 cm/5°/h 9,8 cm/850 cc	biely	612 ks x 18 kart. = 11016 ks/H pal
2213009804	d 13,0 cm/5°/h 9,8 cm/850 cc	šedý NIR	612 ks x 18 kart. = 11016 ks/H pal
2214010901	d 14,0 cm/5°/h 10,9 cm/1000 cc	čierno-šedý	55 ks x 256 = 14080 ks/H pal
2214010902	d 14,0 cm/5°/h 10,9 cm/1000 cc	terakota	55 ks x 256 = 14080 ks/H pal
2214010903	d 14,0 cm/5°/h 10,9 cm/1000 cc	biely	55 ks x 256 = 14080 ks/H pal
2214010904	d 14,0 cm/5°/h 10,9 cm/1000 cc	šedý NIR	55 ks x 256 = 14080 ks/H pal
2315012001	d 15,0 cm /5°/ h 12,0 cm/1,5 L	čierno-šedý	50 ks x 196 = 9800 ks/H pal
2315012002	d 15,0 cm /5°/ h 12,0 cm/1,5 L	terakota	50 ks x 196 = 9800 ks/H pal
2315012003	d 15,0 cm /5°/ h 12,0 cm/1,5 L	biely	50 ks x 196 = 9800 ks/H pal
2315012004	d 15,0 cm /5°/ h 12,0 cm/1,5 L	šedý NIR	50 ks x 196 = 9800 ks/H pal
2317013301	d 17,0 cm /5°/ h 13,3 cm/2,0 L	čierno-šedý	50 ks x 164 = 8200 ks/H pal
2317013302	d 17,0 cm /5°/ h 13,3 cm/2,0 L	terakota	50 ks x 164 = 8200 ks/H pal
2317013303	d 17,0 cm /5°/ h 13,3 cm/2,0 L	biely	50 ks x 164 = 8200 ks/H pal
2317013304	d 17,0 cm /5°/ h 13,3 cm/2,0 L	šedý NIR	50 ks x 164 = 8200 ks/H pal
2319014801	d 19,0 cm /5°/ h 14,8 cm/3,0 L	čierno-šedý	40 ks x 132 = 5280 ks/H pal
2319014802	d 19,0 cm /5°/ h 14,8 cm/3,0 L	terakota	40 ks x 132 = 5280 ks/H pal
2319014803	d 19,0 cm /5°/ h 14,8 cm/3,0 L	biely	40 ks x 132 = 5280 ks/H pal
2319014804	d 19,0 cm /5°/ h 14,8 cm/3,0 L	šedý NIR	40 ks x 132 = 5280 ks/H pal
2319014805	d 19,0 cm /5°/ h 14,8 cm/3,0 L	VIO LET	40 ks x 132 = 5280 ks/H pal
2323018001	d 23,0 cm /5°/ h 18,0 cm/5,0 L	čierno-šedý	40 ks x 92 = 3680 ks/H pal
2323018002	d 23,0 cm /5°/ h 18,0 cm/5,0 L	terakota	40 ks x 92 = 3680 ks/H pal
2323018003	d 23,0 cm /5°/ h 18,0 cm/5,0 L	biely	40 ks x 92 = 3680 ks/H pal
2323018004	d 23,0 cm /5°/ h 18,0 cm/5,0 L	šedý NIR	40 ks x 92 = 3680 ks/H pal
2326021101	d 26,0 cm /5°/ h 21,1 cm/7,5 L	čierno-šedý	30 ks x 68 = 2040 ks/H pal
2326021102	d 26,0 cm /5°/ h 21,1 cm/7,5 L	terakota	30 ks x 68 = 2040 ks/H pal
2326021103	d 26,0 cm /5°/ h 21,1 cm/7,5 L	biely	30 ks x 68 = 2040 ks/H pal
2326021104	d 26,0 cm /5°/ h 21,1 cm/7,5 L	šedý NIR	30 ks x 68 = 2040 ks/H pal
2329022801	d 29,0 cm /5°/ h 22,8 cm/10,0 L	čierno-šedý	25 ks x 56 = 1400 ks/H pal
2329022802	d 29,0 cm /5°/ h 22,8 cm/10,0 L	terakota	25 ks x 56 = 1400 ks/H pal
2329022803	d 29,0 cm /5°/ h 22,8 cm/10,0 L	biely	25 ks x 56 = 1400 ks/H pal
2329022804	d 29,0 cm /5°/ h 22,8 cm/10,0 L	šedý NIR	25 ks x 56 = 1400 ks/H pal



Misky



Kód	rozmer	farba	balenie/pal.
2217008501	d 17,0 cm/h 8,5 cm/1,6 L	čierno-šedý	80 ks x 144 = 11520 ks/H pal
2217008502	d 17,0 cm/h 8,5 cm/1,6 L	terakota	80 ks x 144 = 11520 ks/H pal
2217008503	d 17,0 cm/h 8,5 cm/1,6 L	biely	80 ks x 144 = 11520 ks/H pal
2217008504	d 17,0 cm/h 8,5 cm/1,6 L	šedý NIR	80 ks x 144 = 11520 ks/H pal
2219009501	d 19,0 cm/h 9,5 cm/2,1 L	čierno-šedý	75 ks x 112 = 8400 ks/H pal
2219009502	d 19,0 cm/h 9,5 cm/2,1 L	terakota	75 ks x 112 = 8400 ks/H pal
2219009503	d 19,0 cm/h 9,5 cm/2,1 L	biely	75 ks x 112 = 8400 ks/H pal
2219009504	d 19,0 cm/h 9,5 cm/2,1 L	šedý NIR	75 ks x 112 = 8400 ks/H pal
2221010501	d 21,0 cm/h 10,5 cm/3,0 L (na chryzantémy)	čierno-šedý	60 ks x 92 = 5520 ks/H pal
2221010502	d 21,0 cm/h 10,5 cm/3,0 L (na chryzantémy)	terakota	60 ks x 92 = 5520 ks/H pal
2221010503	d 21,0 cm/h 10,5 cm/3,0 L (na chryzantémy)	biely	60 ks x 92 = 5520 ks/H pal
2221010504	d 21,0 cm/h 10,5 cm/3,0 L (na chryzantémy)	šedý NIR	60 ks x 92 = 5520 ks/H pal



Kvetináč hranatý



Kód	rozmer	farba	balenie/pal.
2309009501	d 9,0 cm /5°/ h 9,5 cm/0,5 L	čierno-šedý	18 ks x 1376 = 24768 ks/H pal
2309009502	d 9,0 cm /5°/ h 9,5 cm/0,5 L	terakota	18 ks x 1376 = 24768 ks/H pal
2309009503	d 9,0 cm /5°/ h 9,5 cm/0,5 L	biely	18 ks x 1376 = 24768 ks/H pal
2309009504	d 9,0 cm /5°/ h 9,5 cm/0,5 L	šedý NIR	18 ks x 1376 = 24768 ks/H pal



Závesný kvetináč



Kód	názov	farba	rozmer	balenie/pal.
2221014401	W21	čierno-šedý	d 21,0 cm/h 14,4 cm/3,0 L	40 ks x 160 = 5600 ks/ H pal
2221014402	W21	terakota	d 21,0 cm/h 14,4 cm/3,0 L	40 ks x 160 = 5600 ks/ H pal
2221014403	W21	biely	d 21,0 cm/h 14,4 cm/3,0 L	40 ks x 160 = 5600 ks/ H pal
2221014404	W21	šedý NIR	d 21,0 cm/h 14,4 cm/3,0 L	40 ks x 160 = 5600 ks/ H pal
2223015401	W23	čierno-šedý	d 23,0 cm/h 15,4 cm/4,0 L	40 ks x 115 = 4600 ks/ H pal
2223015402	W23	terakota	d 23,0 cm/h 15,4 cm/4,0 L	40 ks x 115 = 4600 ks/ H pal
2223015403	W23	biely	d 23,0 cm/h 15,4 cm/4,0 L	40 ks x 115 = 4600 ks/ H pal
2223015404	W23	šedý NIR	d 23,0 cm/h 15,4 cm/4,0 L	40 ks x 115 = 4600 ks/ H pal
2225515801	W25	čierno-šedý	d 25,5 cm/h 15,8 cm/5,0 L	60 ks x 54 = 3240 ks/ H pal
2225515802	W25	terakota	d 25,5 cm/h 15,8 cm/5,0 L	60 ks x 54 = 3240 ks/ H pal
2225515803	W25	biely	d 25,5 cm/h 15,8 cm/5,0 L	60 ks x 54 = 3240 ks/ H pal
2225515804	W25	šedý NIR	d 25,5 cm/h 15,8 cm/5,0 L	60 ks x 54 = 3240 ks/ H pal



LEN NA
OBJEDNÁVKU

Hák k závesnému kvetináču



Kód	názov	farba	rozmer	balenie/pal.
2236003501	Z36	čierno-šedý	d 3,5 cm/h 36,0 cm	20/500 ks x 18 = 9000 ks/H pal
2236003502	Z36	terakota	d 3,5 cm/h 36,0 cm	20/500 ks x 18 = 9000 ks/H pal
2236003503	Z36	biely	d 3,5 cm/h 36,0 cm	20/500 ks x 18 = 9000 ks/H pal
2236003504	Z36	šedý NIR	d 3,5 cm/h 36,0 cm	20/500 ks x 18 = 9000 ks/H pal
2247003501	Z46	čierno-šedý	d 3,5 cm/h 47,0 cm	20/500 ks x 18 = 9000 ks/H pal
2247003502	Z46	terakota	d 3,5 cm/h 47,0 cm	20/500 ks x 18 = 9000 ks/H pal
2247003503	Z46	biely	d 3,5 cm/h 47,0 cm	20/500 ks x 18 = 9000 ks/H pal
2247003504	Z46	šedý NIR	d 3,5 cm/h 47,0 cm	20/500 ks x 18 = 9000 ks/H pal

V prípade záujmu možno objednať aj iné farby.

Závesné kvetináče IPP



Kód	názov	rozmer	farba	balenie
46600	HP LUX WR	25/16,2 cm/5 l	zelený	1000 ks/pal
46605	HP LUX WR	25/16,2 cm/5 l	biely	1000 ks/pal
46610	HP LUX WR	25/16,2 cm/5 l	terakota	1000 ks/pal
46630	HP DECOR WR	27/18,5 cm/7 l	zelený	800 ks/pal
46635	HP DECOR WR	27/18,5 cm/7 l	biely	800 ks/pal
46640	HP DECOR WR	27/18,5 cm/7 l	terakota	800 ks/pal
46660	Hák	46 cm	zelený	400 ks/kartón
46665	Hák	46 cm	biely	400 ks/kartón
46670	Hák	46 cm	terakota	400 ks/kartón
46958	HP LUX WR	23/14,2 cm/3,5 l	zelený	1000 ks/pal
46960	HP LUX WR	23/14,2 cm/3,5 l	biely	1000 ks/pal
46962	HP LUX WR	23/14,2 cm/3,5 l	terakota	1000 ks/pal

Závesné kvetináče SOPARCO



Kód	názov	rozmer	farba	balenie
37140	ONDINE 6 l+2 l	26,4 x 23,5 cm	borovicovo zelený	35 ks/kart, 16 kart/pal
37150	ONDINE 6 l+2 l	26,4 x 23,5 cm	béžový	35 ks/kart, 16 kart/pal
37152	ONDINE 6 l+2 l	26,4 x 23,5 cm	fu ksia	35 ks/kart, 16 kart/pal
37154	ONDINE 6 l+2 l	26,4 x 23,5 cm	zelený	35 ks/kart, 16 kart/pal
37158	ONDINE 6 l+2 l	26,4 x 23,5 cm	biely	35 ks/kart, 16 kart/pal
37160	27 NJ WR	27 x 16,2 cm 6(5,6) l	šedý	96 ks/kart/12 kart/pal
37162	27 NJ WR	27 x 16,2 cm 6(5,6) l	fialový	96 ks/kart, 12 kart/pal
37164	27 NJ WR	27 x 16,2 cm 6(5,6) l	slivkovo-modrý	96 ks/kart, 12 kart/pal
37166	27 NJ WR	27 x 16,2 cm 6(5,6) l	fu ksia	96 ks/kart, 12 kart/pal
37168	27 NJ WR	27 x 16,2 cm 6(5,6) l	zelený	96 ks/kart, 12 kart/pal
37170	27 NJ WR	27 x 16,2 cm 6(5,6) l	červený	96 ks/kart, 12 kart/pal
37176	27 NJ WR	27 x 16,2 cm 6(5,6) l	šedo-hnedý	96 ks/kart, 12 kart/pal
37180	27 NJ WR	27 x 16,2 cm 6(5,6) l	borovicovo zelený	96 ks/kart, 12 kart/pal
37182	27 NJ WR	27 x 16,2 cm 6(5,6) l	biely	96 ks/kart, 12 kart/pal
37200	25 NJ WR	25 x 15,4 cm 5(4,5) l	šedý	96 ks/kart, 12 kart/pal
37202	25 NJ WR	25 x 15,4 cm 5(4,5) l	fialový	96 ks/kart, 12 kart/pal
37204	25 NJ WR	25 x 15,4 cm 5(4,5) l	slivkovo-modrý	96 ks/kart, 12 kart/pal
37206	25 NJ WR	25 x 15,4 cm 5(4,5) l	fu ksia	96 ks/kart, 12 kart/pal
37208	25 NJ WR	25 x 15,4 cm 5(4,5) l	zelený	96 ks/kart, 12 kart/pal
37210	25 NJ WR	25 x 15,4 cm 5(4,5) l	červený	96 ks/kart, 12 kart/pal
37216	25 NJ WR	25 x 15,4 cm 5(4,5) l	šedo-hnedý	96 ks/kart, 12 kart/pal
37220	25 NJ WR	25 x 15,4 cm 5(4,5) l	borovicovo zelený	96 ks/kart, 12 kart/pal
37222	25 NJ WR	25 x 15,4 cm 5(4,5) l	biely	96 ks/kart, 12 kart/pal



Kód	názov	rozmer	farba	balenie
45912	LBCZ	12,0 l 32/20,7 cm 5°	čierny	900 ks/pal
45915	LBCZ	15,0 l 34/22,2 cm 5°	čierny	666 ks/pal
45920	LBCZ	20,0 l 38/24,7 cm 5°	čierny	520 ks/pal
45925	LBCZ	25,0 l 41/26,5 cm	čierny	420 ks/pal
45927	LBCZ	35,0 l 45,9/32 cm 5°	čierny	185 ks/pal
46922	LBCZ	2 l 17,6 cm/11,2 v	čierny	4680 ks/pal
46924	LBCZ	3 l 20 cm/12,7 v	čierny	3600 ks/pal
46926	LBCZ	4 l 22 cm/14,3 v	čierny	2300 ks/pal
46928	LBCZ	5 l 23,7 cm/15,4 v	čierny	1800 ks/pal
46930	LBCZ	7,5 l 27 cm/17,6 v	čierny	1520 ks/pal
46932	LBCZ	10 l 30 cm/19,4 v	čierny	1020 ks/pal





Kód	názov	rozmer	farba	balenie
46876	SBX	1,5 l/15 cm/12 v	čierny	6360 ks/pal
46880	SBX	2 l/17 cm/13,5 v	čierny	4620 ks/pal
46882	SBX	2,5 č. 2,5 l/18 cm/14,5 v	čierny	3744 ks/pal
46884	SBX	3 l/19 cm/15 v	čierny	3300 ks/pal
46894	SBX	4 l/21 cm/16 v	čierny	2484 ks/pal
46896	SBX	5 l/23 cm/18,3 v	čierny	2116 ks/pal
46898	SBX	7,5 l/26 cm/20,5 v	čierny	1120 ks/pal
46900	SBX	10 l/29 cm/22,9 v	čierny	980 ks/pal
46902	SBX	12 l/31 cm/25,5 v	čierny	720 ks/pal
46903	SBX	15 l/32,7 cm/25,8 v	čierny	600 ks/pal



Kód	názov	rozmer	farba	balenie
45929	H-LSR	45,0 l 46/33,5 cm v 5°	čierny	150 ks/pal
45930	H-LSR	65,0 l 54/35 cm v 5°	čierny	120 ks/pal



Kód	názov	rozmer	farba
45932	Kontajner	90,0 l 67/35 cm v 8°	čierny



Kód	názov	rozmer	farba	balenie
46864	na ruže RP	2 l/14 cm p/18 cm v	čierny	4224 ks/pal
46866	na ruže RP	3 l/16 cm p/20,5 cm v	čierny	3724 ks/pal
46868	na ruže RP	4 l/18,5 cm p/21,5 cm v	čierny	3096 ks/pal
46870	na ruže RP	7 l/22 cm p/25,6 cm v	čierny	1650 ks/pal



Kód	názov	rozmer	farba	balenie
45892	Transportné plato FV122	24x kvetináč 9 x 9 cm	čierny	572 ks/pal
46700	VKR	3 l 15,8 x 15,8 x 16 cm	čierny	2520 ks/pal
46715	vysoký	0,8 l 9 x 9 x 14 cm	čierny	7488 ks/pal
46774	Hranatý kvetináč	9 x 9 x 10 cm EX 500 cc	čierny	1260k/18876p
46780	Hranatý kvetináč	11 x 11 x 12 cm EX 1000 cc	čierny	660k/10000p
46790	Hranatý kvetináč	15 x 15 x 15 cm EX 2300 cc	čierny	4410 ks/pal
46796	Hranatý kvetináč	20 x 20 x 23 cm H 5700 cc	čierny	2040 ks/pal



Kód	názov	rozmer	farba	balenie
46935	na rezané kvety	3,0 l 18,5/17 cm v	čierny	7500 ks/pal H
46937	na rezané kvety	4,5 l 21,5/19,6 cm v	čierny	4500 ks/pal H
46939	na rezané kvety	5 23/20 cm v	čierny	4800 ks/pal H
46941	na rezané kvety	8 l 26,5/21 cm v	čierny	4140 ks/pal H
46943	na rezané kvety	10 l 26/25 cm v	čierny	3600 ks/pal H
46945	na rezané kvety	13 l 29/35 cm v	čierny	1500 ks/pal H

Multiplatá MODIFORM

Multiplato 73



Kód	rozmer
31815	50 mm/62 cc - 52,5 x 30,5 cm

Multiplato 150



Kód	rozmer
31825	v 43 mm/25 cc - 52,5 x 30,5 cm

Multiplato 60



Kód	rozmer
31830	v 45 mm/80 cc - 52,5 x 30,5 cm

Multiplato 48



Kód	rozmer
31856	v 50 mm/96 cc - 52,5 x 30,5 cm

Multiplato 240

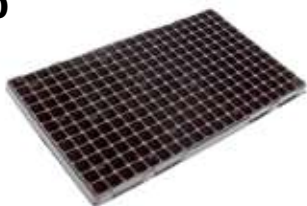

Kód	rozmer
31920	v 30 mm/7,5 cc - 49 x 29 cm

Multiplato 126



Kód	rozmer
31950	v 32 mm/25 cc - 53 x 30 cm

Multiplato 140



Kód	rozmer
31961	v 50 mm/35 cc - 56 x 35 cm

Clajette 2x 10



Kód	rozmer
33545	156 cc 2-pack 31 x 27 cm

Endpack 6



Kód	rozmer
33550	192 cc pack 28 x 12 cm

Endpack 8



Kód	rozmer
33555	142 cc pack 28 x 12 cm

Endpack 10



Kód	rozmer
335600	106 cc pack 28 x 12 cm

Rúčka



Kód	rozmer
33575	40 cm

Výsevné plato



Kód	rozmer
33590	58 x 38 cm, výška 3,5 cm

Multiplatá MODIFORM

Normpack 406



Kód	rozmer
33799	6x 13/12 cm - 56 x 25 cm

Normpack 408



Kód	rozmer
33801	8x 13/12 cm - 56 x 25 cm

Normpack 408



Kód	rozmer
33802	8x 13/12 cm - 56 x 25 cm s dierami

Normpack 409



Kód	rozmer
33803	9x 12 cm - 56 x 25 cm s dierami

Normpack 418



Kód	rozmer
33805	18x 9 cm - 56 x 25 cm

Normpack 418



Kód	rozmer
33806	18x 9 cm - 56 x 25 cm s dierami

Normpack 488



Kód	rozmer
33915	8x 12 cm - 56 x 25 cm

Normpack 478



Kód	rozmer
33918	8x 13 cm - 56 x 25 cm s dierami

Normpack 488



Kód	rozmer
33920	8x 12 cm - 56 x 25 cm s dierami



Normpack 488



Kód	rozmer
33921	8x 12 cm - 56 x 25 cm s dierami

Multiplatá MODIFORM

Normpack 490



Kód

rozmer

33922

10x 11,5 - 56 x 25 cm s dierami

Universal



Kód

rozmer

33925

6/8/12x 9/13 cm - 40 x 28 cm

Normpack 245



Kód

rozmer

33930

20x 7 cm hranaté - 40 x 28 cm

Dänish



Kód

rozmer

33952

15x 10,5/11 cm - 54 x 31,5 cm

Dänish



Kód

rozmer

33955

15x 10,5/11 cm - 53 x 30 cm

Dänish



Kód

rozmer

33956

15x 10,5/11 cm - 53 x 30 cm s dierami

Dänish



Kód

rozmer

33960

18x 9 cm - 53 x 30 cm

Dänish



Kód

rozmer

33961

18x 9 cm - 53 x 30 cm s dierami

Dänish



Kód

rozmer

33966

8x 13/14 cm 8° - 53 x 30 cm

Eurodan



Kód

rozmer

33980

6x 16 cm - 56 x 31,5 cm

LEN NA
OBJEDNÁVKU

Multiplatá MODIFORM

Eurodan



Kód	rozmer
339811	6x 15 cm - 56 x 31,5 cm s dierami

Eurodan



Kód	rozmer
339812	8x 15 cm - 8° 56 x 31,5 cm s dierami

Eurodan



Kód	rozmer
339813	5x 17 cm - 56 x 31,5 cm s dierami

Eurodan



Kód	rozmer
33982	12x 12 cm - 56 x 31,5 cm

Eurodan



Kód	rozmer
33983	12x 12 cm - 56 x 31,5 cm s dierami

Eurodan



Kód	rozmer
33984	18x 9 cm hranaté - 56 x 31,5 cm s dierami

Dänish



Kód	rozmer
33990	10x 13 cm - 56 x 31,5 cm



LEN NA
OBJEDNÁVKU



Kód	názov	rozmer	farba
11241P	TERRA kvetináč	11/8,5 cm 0,5 l	terakota
11242P	TERRA kvetináč	13/10 cm 0,7 l	terakota
11243P	TERRA kvetináč	15/11,5 cm 1 l	terakota
11244P	TERRA kvetináč	17,5/13,5 cm 2 l	terakota
11245P	TERRA kvetináč	20/15,5 cm 3 l	terakota
11246P	TERRA kvetináč	25/19,5 cm 5 l	terakota
11247P	TERRA kvetináč	30/23,5 cm 8 l	terakota
11248P	TERRA kvetináč	35/27,5 cm 13 l	terakota
11249P	TERRA kvetináč	40/31,5 cm 20 l	terakota
11250P	TERRA kvetináč	45/35 cm 27 l	terakota
11251P	TERRA kvetináč	50/39 cm 38 l	terakota
11252P	TERRA kvetináč	55/43 cm 48 l	terakota
11253P	TERRA kvetináč	64/50 cm 78 l	terakota



14241P	TERRA podmiska	9/1,2 cm	terakota
14242P	TERRA podmiska	11/1,4 cm	terakota
14243P	TERRA podmiska	12/1,6 cm	terakota
14244P	TERRA podmiska	14/1,9 cm	terakota
14245P	TERRA podmiska	17/2,2 cm	terakota
14246P	TERRA podmiska	21/2,7 cm	terakota
14247P	TERRA podmiska	25/3,3 cm	terakota
14248P	TERRA podmiska	29/3,8 cm	terakota
14249P	TERRA podmiska	33/4,4 cm	terakota
14250P	TERRA podmiska	37/4,9 cm	terakota
14251P	TERRA podmiska	41/5,5 cm	terakota
14252P	TERRA podmiska	46/6 cm	terakota
14253P	TERRA podmiska	54/6,9 cm	terakota



15121P	TERRA misa	20/9,5 cm	terakota
15122P	TERRA misa	25/11,5 cm	terakota
15123P	TERRA misa	30/13 cm 6 l	terakota
15124P	TERRA misa	35/15 cm	terakota
15125P	TERRA misa	40/17 cm 14,5 l	terakota



Kód	názov	rozmer	farba
15478P1	Obal pre orchidey Coubi	12,5/14,7 cm 1,1 l	zelený
15478P2	Obal pre orchidey Coubi	12,5/14,7 cm 1,1 l	transparent



Kód	názov	rozmer	farba
11081P	TERRA hran. kv.	15/13 cm 1,7 l	terakota
11082P	TERRA hran. kv.	19/16 cm 3,5 l	terakota
11083P	TERRA hran. kv.	24/20 cm 7 l	terakota
11084P	TERRA hran. kv.	30/25 cm 13,8 l	terakota
11085P	TERRA hran. kv.	37/30 cm 25,2 l	terakota
11086P	TERRA hran. kv.	45/35 cm 42 l	terakota



14081P	TERRA hr. podm.	14/1,9 cm	terakota
14082P	TERRA hr. podm.	17/2,4 cm	terakota
14083P	TERRA hr. podm.	22/3 cm	terakota
14084P	TERRA hr. podm.	27/3,8 cm	terakota
14085P	TERRA hr. podm.	34/4,5 cm	terakota
14086P	TERRA hr. podm.	41/5,5 cm	terakota



14024P	CROWN kv.	48/26,4 cm 16 l	terakota
---------------	-----------	-----------------	----------



Kód	názov	rozmer	farba
41120	CIOTOLA CAMPANA kv.	45 cm	terakota
41140	CIOTOLA CAMPANA kv.	50 cm	terakota
41160	CIOTOLA CAMPANA kv.	60 cm	terakota
41130	CAMPANA pod.	37/45 cm	terakota
41150	CAMPANA pod.	40/50 cm	terakota
41170	CAMPANA pod.	45/60 cm	terakota

Kód	názov	rozmer	farba
41700	Garden hrantík	40 x 17 x 15 h cm 5,1 l	terakota
41701	Garden hrantík	40 x 17 x 15 h cm 5,1 l	hnedý
41703	Garden hrantík	40 x 17 x 15 h cm 5,1 l	mramor
41704	Garden hrantík	40 x 17 x 15 h cm 5,1 l	antracit
41710	Garden miska	40 x 17 x 3 cm	terakota
41711	Garden miska	40 x 17 x 3 cm	hnedá
41713	Garden miska	40 x 17 x 3 cm	mramor
41714	Garden miska	40 x 17 x 3 cm	antracit
41720	Garden hrantík	50 x 17 x 15 h cm 6,7 l	terakota
41721	Garden hrantík	50 x 17 x 15 h cm 6,7 l	hnedý
41723	Garden hrantík	50 x 17 x 15 h cm 6,7 l	mramor
41724	Garden hrantík	50 x 17 x 15 h cm 6,7 l	antracit
41730	Garden miska	50 x 17 x 3 cm	terakota
41731	Garden miska	50 x 17 x 3 cm	hnedá
41733	Garden miska	50 x 17 x 3 cm	mramor
41734	Garden miska	50 x 17 x 3 cm	antracit
41740	Garden hrantík	60 x 17 x 15 h cm 8,2 l	terakota
41741	Garden hrantík	60 x 17 x 15 h cm 8,2 l	hnedý
41743	Garden hrantík	60 x 17 x 15 h cm 8,2 l	mramor
41744	Garden hrantík	60 x 17 x 15 h cm 8,2 l	antracit
41750	Garden miska	60 x 17 x 3 cm	terakota
41751	Garden miska	60 x 17 x 3 cm	hnedá
41753	Garden miska	60 x 17 x 3 cm	mramor
41754	Garden miska	60 x 17 x 3 cm	antracit
41760	Garden hrantík	80 x 17 x 15 h cm 11,2 l	terakota
41761	Garden hrantík	80 x 17 x 15 h cm 11,2 l	hnedý
41763	Garden hrantík	80 x 17 x 15 h cm 11,2 l	mramor
41764	Garden hrantík	80 x 17 x 15 h cm 11,2 l	antracit
41770	Garden miska	80 x 17 x 3 cm	terakota
41771	Garden miska	80 x 17 x 3 cm	hnedá
41773	Garden miska	80 x 17 x 3 cm	mramor
41774	Garden miska	80 x 17 x 3 cm	antracit
41780	Garden hrantík	100 x 17 x 15 h cm 14 l	terakota
41781	Garden hrantík	100 x 17 x 15 h cm 14 l	hnedý
41783	Garden hrantík	100 x 17 x 15 h cm 14 l	mramor
41784	Garden hrantík	100 x 17 x 15 h cm 14 l	antracit
41790	Garden miska	100 x 17 x 3 cm	terakota
41791	Garden miska	100 x 17 x 3 cm	hnedá
41793	Garden miska	100 x 17 x 3 cm	mramor
41794	Garden miska	100 x 17 x 3 cm	antracit



Hrantíky a príslušenstvo



Kód	názov	rozmer	farba
41800	FANTAZIE hrant	40 x 19,5 x 17,5 h cm 2,0/6,5 l	terakota
41801	FANTAZIE hrant	40 x 19,5 x 17,5 h cm 2,0/6,5 l	hnedý
41803	FANTAZIE hrant	40 x 19,5 x 17,5 h cm 2,0/6,5 l	mramor
41804	FANTAZIE hrant	40 x 19,5 x 17,5 h cm 2,0/6,5 l	antracit
41840	FANTAZIE hrant	60 x 19,5 x 17,5 h cm 3,5/10 l	terakota
41841	FANTAZIE hrant	60 x 19,5 x 17,5 h cm 3,5/10 l	hnedý
41843	FANTAZIE hrant	60 x 19,5 x 17,5 h cm 3,5/10 l	mramor
41844	FANTAZIE hrant	60 x 19,5 x 17,5 h cm 3,5/10 l	antracit
41860	FANTAZIE hrant	80 x 19,5 x 17,5 h cm 5,0/13,5 l	terakota
41861	FANTAZIE hrant	80 x 19,5 x 17,5 h cm 5,0/13,5 l	hnedý
41863	FANTAZIE hrant	80 x 19,5 x 17,5 h cm 5,0/13,5 l	mramor
41864	FANTAZIE hrant	80 x 19,5 x 17,5 h cm 5,0/13,5 l	antracit



Kód	názov	rozmer	farba
41990	Držiak	na hranu 12 cm	terakota
41991	Držiak	na rúrku 12 cm	terakota
41992	Držiak	na hranu 12 cm	hnedý
41993	Držiak	na rúrku 12 cm	hnedý
41995	Držiak	na hranu 15 cm	terakota
41996	Držiak	na rúrku 15 cm	terakota
41997	Držiak	na hranu 15 cm	hnedý
41998	Držiak	na rúrku 15 cm	hnedý



Kód	názov	rozmer	farba
419990	Kovový držiak	2 ks/bal.	Antracit
419991	Kovový držiak	2 ks/bal.	Terracota



Kód	názov	rozmer	farba
15015P	kôš na cibuľoviny Onion II.	21,5/5,4 cm	lesná zeleň
15016P	kôš na cibuľoviny Onion II.	26,5/5,6 cm	lesná zeleň
15017P	kôš na cibuľoviny Onion II.	31,5/5,6 cm	lesná zeleň



Kód	názov	rozmer	farba	balenie
78401000	Záhonový štítok	34/9 x 6 cm x 34 cm	slonovinová	100 ks
78305007	Záhonový štítok	13,5/5 x 3 cm x 13,5 cm	slonovinová	250 ks



Kód	názov	rozmer	farba	balenie
78105007	Záhonový štítok	EP10 10,0 x 1,5 cm	slonovinová	1000 ks
78205007	Záhonový štítok	EP14 14,0 x 1,8 cm	slonovinová	250 ks



Kód	názov	rozmer	farba	balenie
35510	Rýchloviazač	115 mm	čierna	1000 ks
35520	Rýchloviazač	145 mm	čierna	1000 ks

Krhly



Kód	názov	objem	farba	balenie
42000	Spring	1,7 l	rôzna	8x 58/pal.
42010	Spring	2,5 l	rôzna	6x 40/pal.
42020	Spring	4,5 l	rôzna	6x 32/pal.
42030	Spring	8 l	rôzna	5x 20/pal.
42040	Spring	10,5 l	rôzna	4x 16/pal.
42050	Spring	13,5 l	rôzna	4x 14/pal.



Kód	názov	objem	farba	balenie
42080	Krhla s ružicou	5 l	zelená	20x 140/pal.
42090	Krhla s ružicou	10 l	zelená	10x 140/pal.

Selektívne herbicídy

Bofix



Kód	balenie	m. j.
80662	250 ml	ks
80663	100 ml	ks
80661	1 l	ks

Agil 100EC



Kód	balenie	m. j.
80071	100 ml	ks

Stomp Aqua



Kód	balenie	m. j.
842320	250 ml	ks

Dicopur M750



Kód	balenie	m. j.
81370	500 ml	ks

Totálne herbicídy

Roundup biaktiv M



Kód	balenie	m. j.
83902	1 l	l
83922	20 l	l

Touchdown System 4



Kód	balenie	m. j.
84710	50 ml	ks

Kaput Green



Kód	balenie	m. j.
82468	250 ml	ks
82466	500 ml	ks
82464	1 l	ks

Clinic UP



Kód	balenie	m. j.
80950	5 l	l
80945	20 l	l

Keeper záhrada



Kód	balenie	m. j.
83890	250 ml	ks

Keeper liquid



Kód	balenie	m. j.
83891	10 ml	ks

Champion 50 WG

Kód	balenie
823350	10 x 20 g

Askon

Kód	balenie
80370	10 ml

Energy Magnicur

Kód	balenie
81560	15 ml

Cabrio Top

Kód	balenie
80791	3 x 20 g

Thiovit

Kód	balenie
84631	5 x 60 g

Prolectus

Kód	balenie
83500	5 x 12 g

Signum

Kód	balenie
84050	15 g

Dynali

Kód	balenie
81541	6,5 ml
81540	250 ml

Rock Effect

Kód	balenie
83782	100 ml

Fungimat Magnicur

Kód	balenie
81711	50 ml

Fungicídy

Cantus



Kód	balenie	m. j.
80810	5x 12 g	ks

Qualy 300EC



Kód	balenie	m. j.
83530	5 ml	ks

Cuproxat SC



Kód	balenie	m. j.
81111	100 ml	ks

POLYRAM WG



Kód	balenie	m. j.
83444	5x 20 g	ks

Insekticídy

Apollo 50 SC



Kód	balenie	m. j.
80332	8 ml	ks

Sanium Ultra



Kód	balenie	m. j.
84170	2x 5 ml	ks
84172	30 ml	ks

Karate Zeon



Kód	balenie	m. j.
82482	5 ml	ks
82483	50 ml	ks

Metarex



Kód	balenie	m. j.
82994	100 g	ks
82993	3x 100 g	ks

Mospilan 20 SP M



Kód	balenie	m. j.
83127	0,6 g	ks
83126	3x 0,6 g	ks
83125	1,5 g	ks
83123	15 g	ks

Vertimec 1,8 EC



Kód	balenie	m. j.
84911	10 ml	ks

Spintor



Kód	balenie	m. j.
84192	6 ml	ks
84191	25 ml	ks

GRANULAX - proti slimákom



Kód	balenie	m. j.
81381	250 g	ks

Champion Almus (vošky)



Kód	balenie	m. j.
82337	250 ml	ks
823370	500 ml	ks
823371	200 ml	ks

Gondola



Kód	balenie	m. j.
81374	2 ml	ks

Mavrik 2F



Kód	balenie	m. j.
82940	5 ml	ks

Nissorun 10 WP



Kód	balenie	m. j.
83193	5x 10 g	ks

Ortus 5 SC



Kód	balenie	m. j.
83301	10 ml	ks

Talpa Raus



Kód	balenie	m. j.
84408	1 kg	ks

Predjarný postrek

Mero stefes + karate zeon

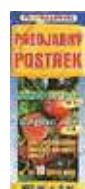

Kód	balenie	m. j.
83470	100 ml + 5 ml	ks
83472	250 ml + 12,5 ml	ks

Ochrana proti hmyzu

Nástraha na mravce (granulát)



Kód	balenie	m. j.
83132	100 g	ks

Sojet - proti muchám (vodorozpustný granulát)



Kód	balenie	m. j.
84130	100 g	ks

Agita - proti muchám



Kód	balenie	m. j.
80080	100 g	ks
80079	400 g	ks

Biotoll prášok proti mravcom



Kód	balenie	m. j.
50173	100 g	ks

Biologická ochrana

NeemAzal T/S



Kód	balenie	m. j.
831190	100 ml	ks

ROOT - likvidátor koreňového systému



Kód	balenie	m. j.
84263	100 ml	ks

Lepidlo na ochranu stromov



Kód	balenie	m. j.
84262	250 ml	ks

FLORA VITA Citro - biologické proti chorobám



Kód	balenie	m. j.
82241	100 ml	ks

FLORA VITA Coco - biologické proti chorobám



Kód	balenie	m. j.
82242	100 ml	ks

Polyversum 5 g - biologické proti chorobám



Kód	balenie	m. j.
82244	100 ml	ks

Trifender - biologické hnojivo s fungicídny m účinkom



Kód	balenie	m. j.
82243	3x 10 g	ks

Novaferm Orion



Kód	balenie	m. j.
81186	250 ml	ks

Novaferm Viva



Kód	balenie	m. j.
81187	250 ml	ks

Chemstop Ecofix



Kód	balenie	m. j.
849983	250 ml	ks

Prídavné látky a hnojivá

Rhodovit - pomocný prípravok pre pestovanie kyslomilných rastlín



Kód	balenie	m. j.
70330	100 g	ks

Symbivit



Kód	balenie	m. j.
70315	150 g	ks
70320	750 g	ks
70321	3 kg	ks
70325	20 kg	ks

Plantasorb - prípravok zadržávajúci pôdnu vlhkosť



Kód	balenie	m. j.
70360	750 g	ks

Oasis EM-1 - pôdne mikrobiologické hnojivo



Kód	balenie	m. j.
81190	100 ml	ks
811900	250 ml	ks

Symbivit paradajky a papriky



Kód	balenie	m. j.
70338	150 g	ks
70340	750 g	ks

Ectovit - pomocný prípravok pre pestovanie rastlín - ihličnany



Kód	balenie	m. j.
70350	300 g	ks

Bio Plantella

Lepové dosky žlté
(entomolog. lepidlo, bez ochr. lehoty)



Kód	balenie	m. j.
849980	5 ks	ks

Lepové dosky biele
(entomolog. lepidlo, bez ochr. lehoty)



Kód	balenie	m. j.
849972	10 ks	ks

Obojstranne lepiaci pás na stromy - vošky, piadivky, mrvce



Kód	balenie	m. j.
849970	5 m	ks

PROTEKT ochr. náter na stromy so železom a haseným vápnom



Kód	balenie	m. j.
849974	1,5 kg	ks

Stimulátory

Stimulátor zakoreňovania AS-1



Kód	balenie	m. j.
80009	75 g	ks

Stimulátor zakoreňovania Vetozen



Kód	balenie	m. j.
80012	300 g	ks

RootMost prírodný koreňový stimulátor na 1000 m², na báze morských rias



Kód	balenie	m. j.
81185	100 ml	ks

Ochrana proti škodcom

Chránič na kmene Treex Flexguard



Kód	rozmery	balenie	m. j.
122005	11 x 80 cm	6 ks	ks
122006	11 x 110 cm	6 ks	ks

Dymovnica proti podzemným škodcom



Kód	balenie	m. j.
79900	5 ks	bal.

Stop škodcom Gel profesionál na hlodavce



Kód	balenie	m. j.
799600	300 g	ks

PROTECT NATURAL - odpudzovač krtov



Kód	balenie	m. j.
799001	50 ks	ks

Swissinno Supercat guillotine - pasca na hlodavce



Kód	m. j.
1551000	ks

Ratimor brodifacoum mäkká nástraha



Kód	balenie	m. j.
52601	150 g	ks

Ratimor brodifacoum parafinové bloky



Kód	balenie	m. j.
52608	300 g	ks

Ratimor plus bromadiolon zrno, obilná nástraha



Kód	balenie	m. j.
52831	150 g	ks

Ratimor plus lepové dosky na myši, extra silná!



Kód	balenie	m. j.
40600	2 ks	ks

Vonkajšia ochrana proti komárom

Rozlúčte sa so sprejmi

S technológiou Thermacell Mosquito Repellent Technology Zone sa zbavíte obťažujúceho hmyzu. Mnohé štúdie potvrdzujú až 98% efektívnosť výrobkov Thermacell pri ochrane pred komármi a iným otravným krv sajúcim hmyzom s ochrannou zónou až 20 m².



THERMACELL®

PROVIDES
20 M²
ZONE
OF PROTECTION

Púzdro pre ručný odpudzovač MR-300 s klipom



Kód	parametre	balenie
AP-CL		12 ks/bal.

Ručný odpudzovač MR-300



Kód	parametre	balenie
MR-300G	olivovo zelený	6 ks/bal.
MR-300L	čierny	6 ks/bal.

Ručný odpudzovač MR-450



Kód	parametre	balenie
MR-450X	čierny	6 ks/bal.

Kempingový odpudzovač



Kód	parametre	balenie
MR-BP		6 ks/bal.

Halo Mini odpudzovač komárov



Kód	parametre	balenie
MR-PSB	modrý	6 ks/bal.

Halo Mini odpudzovač komárov



Kód	parametre	balenie
MR-PSL	graphit	6 ks/bal.

Halo Mini odpudzovač komárov



Kód	parametre	balenie
MR-PSW	biely	6 ks/bal.

Lampáš odpudzovač komárov na terasy



Kód	parametre	balenie
PS-LL2		6 ks/bal.

Náhradné vankúšiky do kempingového odpudzovača



Kód	parametre	balenie
M-48		12 ks/bal.

Náhradné butánové kartuše



Kód	parametre	balenie
C-4		12 ks/bal.

Náhradné náplne na 120 hodín



Kód	parametre	balenie
R-10	30x poduška, 4x bombička	6 ks/bal.

Náhradné náplne na 48 hod



Kód	parametre	balenie
R-4	12x poduška, 4x bombička	12 ks/bal.

Machožrút (proti machu na zámkovú dlažbu)



Kód	balenie	m. j.
82850	1 l	l

Silwet Star zmáčadlo



Kód	balenie	m. j.
84103	1 l	l
841040	15 ml	ks
84105	50 ml	ks

Štepársky vosk Dendrosan



Kód	balenie	m. j.
84261	150 g	ks

Stromový balzam Dendrosan



Kód	balenie	m. j.
84260	150 g	ks

Postrekovače

Rozprašovač ručný VENEZIA



Kód	balenie	m. j.
12045	600 ml	ks
12040	1000 ml	ks

Postrekovač ručný GAMMA



Kód	balenie	m. j.
12005	5 l	ks
12007	7 l	ks
12010	10 l	ks

Postrekovač ručný Thema



Kód	balenie	m. j.
12002	2 l	ks

Postrekovač ručný Skveler



Kód	balenie	m. j.
15901000	1 l	ks
15901001	2 l	ks

Postrekovač chrbtový MIURA s teleskopom



Kód	balenie	m. j.
12012	12 l	ks
12016	16 l	ks
12022	22 l	ks

Postrekovač chrbtový LITHIUM 8
elektrický s teleskopom



Kód	balenie	m. j.
12019	8 l	ks

Postrekovač chrbtový ELECTRA 16l
Li-Ion s teleskopom, elektrický



Kód	balenie	m. j.
12018	16 l	ks

PONTAQUA



Kód	názov
5504	Chlór Šok/Štart 1 kg
5505	Chlór Šok/Štart 3 kg



Kód	názov
5502	Chlórové tablety 200 g 1 kg



Kód	názov
5507	Multifunkčné tablety 20 g 1 kg
5508	Multifunkčné tablety 200 g 1 kg
5509	Multifunkčné tablety 200 g 3 kg



Kód	názov
5511	pH mínus 1,5 kg
5512	pH mínus 6 kg
5513	pH plus 0,8 kg



Kód	názov
5515	Stabilizátor tvrdosti 1 l
5516	Stabilizátor tvrdosti 5 l



Kód	názov
5520	Algacid Super 1 l
5519	Algacid Super 5 l
5521	Algacid 1 l s vôňou aloe vera
5522	Algacid 1 l s vôňou kamilky



Kód	názov
5530	Vločkovač tekutý 1 l
5531	Vločkovač kartuše 8 ks



Kód	názov
5533	Odpeňovač 0,5 l



Kód	názov
5536	Štartovacia sada pre bazény 5v1



Kód	názov
5537	EasySPA sada pre vírivky



Kód	názov
5540	Čistič odvápnovač 1 l



Kód	názov
5542	Čistič gelový alkalický 1 l



Kód	názov
5544	Odstraňovač kovov 1 l



Kód	názov
5545	Čistič filtrov 3x 100 g



Kód	názov
5525	Zazimovač 1 l



Kód	názov
5113391	WHIRLPOOL SET tablety (OXI)



Kód	názov
5112547	OXI tablety 20 g mini 1 kg



Kód	názov
5112973	OXI granulát 1 kg



Kód	názov
6020	Bazénový vysávač s bočnými kefami



Kód	názov
6025	Bazénová kefa rohová



Kód	názov
229100	Ručný vysávač TRI Deluxe OCEAN



Kód	názov
6022	Bazénová kefa zakrivená 46cm



Kód	názov
6023	Bazénová kefa s rukovetou biela



Kód	názov
6024	Bazénová špongia modrá



Kód	názov
6026	Hladinová sieťka modrá



Kód	názov
6027	Dnová sieťka modrá



Kód	názov
6029	Bazénový podberák teleskopický 3 x 40 cm



Kód	názov
6035	Vysávačová hadica modrá d 38/7,5 m VA
6036	Vysávačová hadica modrá d 38/9 m VA
6037	Vysávačová hadica modrá d 38/12 m VA



Kód	názov
229009	Tyč teleskop. 2-dielna Ocean AL 1,8 - 3,6 m
229010	Tyč teleskop. 2-dielna Ocean AL 2,4 - 4,8 m
229011	Tyč teleskop. 2-dielna Ocean AL 3,75 - 7,5 m



Kód	názov
6030	Teleskopická tyč 2 x 180 cm modrá



Kód	názov
2200000	Hadica vysávačová modrá 32/110 cm/bal. 50,6 m
229012	Hadica vysávačová modrá ECO k vysávačom d 38 mm



Kód	názov
5112327	Hadica plávajúca čierna 32 mm/55 cm, bal. 49,5 m
5112328	Hadica plávajúca čierna 38 mm/150 cm, bal. 51 m



Kód	názov
229019	Trň hadicový obojstranný 32 mm
229020	Trň hadicový obojstranný 38 mm
400233	Hadicová spojka d 38 - 32
400234	Adaptér lepiaci biely 38 x 50 ABS
400235	Adaptér lepiaci biely redukovaný d 32 - 38 x 50 ABS



Kód	názov
145625	Hadicová spona 25 - 40 mm NEREZ, 100 ks/bal.



Kód	názov
6038	Dávkovač tabliet Mini
6039	Dávkovač tabliet Maxi



Kód	názov
229008	Dávkovač chlóru plávajúci OCEAN



Kód	názov
6040	Dávkovač tabliet s teplomerom Mini



Kód	názov
6041	Dávkovač tabliet s teplomerom Maxi



Kód	názov
6047	Teplomer bazénový rybička



Kód	názov
6049	Teplomer bazénový delfín



Kód	názov
6050	Teplomer bazénový korytnačka



Kód	názov
6048	Teplomer bazénový kačička



Kód	názov
229018	Teplomer OCEAN guľatý



Kód	názov
6043	Teplomer bazénový biely



Kód	názov
700152	Špongia tvrdená OCEAN (balenie 2 ks)



Kód	názov
5113677	AQUAKRYSTAL - Absorbér masnoty a olejov do skimmra (balenie 2 ks) /24 ks box



Kód	názov
400180	Tester OCEAN tabletkový pH/Cl

Kód	názov
400188	Náhradné tablety do testera DPD1 (chlór)
400189	Náhradné tablety do testera pH



Kód	názov
6042	Tester kvapkový pH & Cl

Kód	názov
5112410	OXY tester



Kód	názov
5112823	Testovacie pásiky 4v1 AquaChek

Kód	názov
5112824	Testovacie pásiky 7v1 AquaChek



Kód	názov
5112825	Testovacie pásiky SALT TEST AquaChek

Kód	názov
899800	Morská soľ špeciál, praná/sušená 1 - 3 mm



Kód	názov	balenie
8000054	Filtročný piesok 0,2 - 0,8 mm	25 kg
8000510	Filtročné sklo 0,5 - 1 mm	25 kg
8000049	Filtročné sklo 0,8 - 1,2 mm	25 kg
8000050	Filtročné sklo AFM 2 - 3 mm	25 kg
5112104	Filtročné sklo AFM 3 - 5 mm	25 kg

Kód	názov	balenie
898808	Filtročné sklo 0,5 - 1 mm	25 kg
5113521	Filtročné sklo 0,5 - 1,25 mm	20 kg
700011	Filtročné sklo 1 - 3 mm	25 kg
5112594	Filtročné sklo AFM 0,4 - 1 mm	21 kg
5112595	Filtročné sklo AFM 1 - 2 mm	21 kg

Netkané textílie mulčovacie

Balená čierna



Kód	hustota	rozmary	m. j.	bal.
21000	50 g/m ²	1,6 x 5 m	ks	20
21100	50 g/m ²	1,6 x 10 m	ks	10
21200	50 g/m ²	3,2 x 5 m	ks	10
21300	50 g/m ²	3,2 x 10 m	ks	5

Balená biela



Kód	hustota	rozmary	m. j.	bal.
20000	17 g/m ²	1,6 x 5 m	ks	50
20100	17 g/m ²	1,6 x 10 m	ks	25
20200	17 g/m ²	3,2 x 5 m	ks	25
20300	17 g/m ²	3,2 x 10 m	ks	12
20400	17 g/m ²	4,2 x 10 m	ks	5
20500	17 g/m ²	4,2 x 20 m	ks	5
20600	17 g/m ²	6,35 x 10 m	ks	5
20700	17 g/m ²	6,35 x 20 m	ks	3

Kotúč čierna



Kód	hustota	rozmary	m. j.
24080	50 g/m ²	0,8 x 100 m	ks
24160	50 g/m ²	1,6 x 100 m	ks
24320	50 g/m ²	3,2 x 100 m	ks

Kotúč hnedá



Kód	hustota	rozmary	m. j.
24060	45 g/m ²	1,6 x 100 m	ks

Kotúč biela



Kód	hustota	rozmary	m. j.
22160	17 g/m ²	1,6 x 100 m	ks
22320	17 g/m ²	3,2 x 100 m	ks
22330	17 g/m ²	6,35 x 100 m	ks
22350	17 g/m ²	12,65 x 100 m	ks
22635	19 g/m ²	6,35 x 100 m	ks
22950	19 g/m ²	9,5 x 100 m	ks
23050	19 g/m ²	10,5 x 100 m	ks
23265	19 g/m ²	12,65 x 100 m	ks
23580	19 g/m ²	15,8 x 100 m	ks

Kotviaci kolík a hák



Kód	názov	m. j.
24100	kotviaci kolík	ks
3200	kotviaci háč	ks
3201	kotviaci háč	ks

Balené



Kód	hustota	rozmary	m. j.
28980	100 g/m ²	1,6 x 5 m	ks
28990	100 g/m ²	1,6 x 10 m	ks

Kotúč 100 g/m²

Kód	rozmary	m. j.
28956	1,05 x 25 m	ks
289531	1,05 x 100 m	ks
28958	1,65 x 50 m	ks
28960	2,1 x 100 m	ks
28962	2,1 x 25 m	ks

Kotúč 130 g/m²

Kód	rozmary	m. j.
28916	3,3 x 50 m	ks
28921	4,2 x 50 m	ks
28926	5,25 x 50 m	ks

Príchytka na pletivo pod trávnu 10 cm



Kód	balenie	m. j.
28711	100 ks	ks
28713	300 ks	ks
28715	500 ks	ks

hlavička 3 cm

Kokosové rohože, plachtičky, Jutenon

Kokosová rohož 350 g/m²



Kód	rozmery	m. j.
311	2 x 50 m	m ²
31	2,4 x 50 m	m ²

Protierózna plná 350 g/m²
balenie 100 m²

Kokosová rohož 400 g/m²



Kód	rozmery	m. j.
3101	2 x 50 m	m ²

Protierózna 400 g/m²

Jutové pásy



Kód	rozmery	m. j.
366	10 cm x 25 m	ks

Geotextília biela



Kód	hustota	rozmery	m. j.
210001	300 g/m ²	2,2 x 50 m	m ²
210000	300 g/m ²	2 x 50 m	m ²
999106	150 g/m ²	2,2 x 50 m	m ²
5113162	400 g/m ²	2 x 50 m	m ²

100 m² rolka - predaj na celé rolky

Membrána proti prerastaniu koreňov



Kód	rozmery	m. j.
9991054	70 cm x 25 m	m ²
99910540	100 cm x 25 m	m ²

Jutenon ECJ sieť 500 g/m²



Kód	rozmery	m. j.
210090	1,22 x 50 m/61 m ²	ks

Protierózna 500 g/m²

Prírodná mulčovačia textília



- vyrobená z jutového vlákna
- biologicky rozložiteľná
- obmedzuje rast buriny, zabraňuje erózií pôdy
- oproti klasickej netkanej textílii umožňuje ľahší prienik vody do pôdneho profilu a lepšiu evaporáciu

Kód	hustota	rozmery	m. j.
210096	300 g/m ²	1 x 10 m	ks

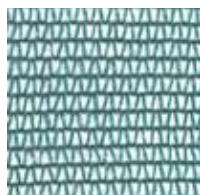
ULTRALIGHTTEX 30 g/m²**30%**

Kód	rozmary	m. j.	
28472	1,5 x 50 m	ks	
28477	2 x 50 m	ks	
28482	3 x 50 m	ks	
28487	6 x 50 m	ks	
28492	9 x 50 m	ks	

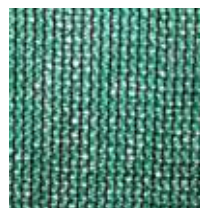
LIGHTTEX 90 g/m²**80%**

Kód	rozmary	m. j.	kart.
28500	1 x 10 m	ks	6
28502	1 x 50 m	ks	-
28574	1,2 x 10 m	ks	6
28575	1,2 x 50 m	ks	-
28504	1,5 x 10 m	ks	6
28506	1,5 x 50 m	ks	-
28508	1,8 x 10 m	ks	6
28511	1,8 x 50 m	ks	-
28541	2 x 10 m	ks	6
28543	2 x 50 m	ks	-

MEDIUMTEX 160 g/m²**90%**

Kód	rozmary	m. j.	kart.
28576	1,2 x 10 m	ks	6
28577	1,2 x 50 m	ks	-
28513	1 x 10 m	ks	6
28515	1 x 50 m	ks	-
28517	1,5 x 10 m	ks	6
28519	1,5 x 50 m	ks	-
28521	1,8 x 10 m	ks	6
28523	1,8 x 50 m	ks	-
28545	2 x 10 m	ks	6
28547	2 x 50 m	ks	-

GOLDTEX 230 g/m²**95%**

Kód	rozmary	m. j.	kart.
28525	1 x 10 m	ks	6
28527	1 x 50 m	ks	-
28529	1,2 x 10 m	ks	6
28531	1,2 x 50 m	ks	-
28533	1,5 x 10 m	ks	6
28535	1,5 x 50 m	ks	-
28537	1,8 x 10 m	ks	6
28539	1,8 x 50 m	ks	-
28549	2 x 10 m	ks	6
28561	2 x 50 m	ks	-

SUPERTEX 260 g/m²**99%**

Kód	rozmary	m. j.	kart.
28578	1 x 10 m	ks	6
28562	1 x 50 m	ks	-
28581	1,5 x 10 m	ks	6
28582	1,5 x 50 m	ks	-
28583	1,8 x 10 m	ks	6
28584	1,8 x 50 m	ks	-
28588	2 x 10 m	ks	6
28589	2 x 50 m	ks	-

Tieniace siete

GREYTEX 160 g/m²

90%

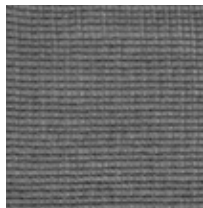

Kód	rozmery	m. j.	kart.
28601	1 x 10 m	ks	6
28603	1,5 x 10 m	ks	6
28604	1,8 x 10 m	ks	6
28605	2 x 10 m	ks	6
28606	1 x 50 m	ks	-
28608	1,5 x 50 m	ks	-
28609	1,8 x 50 m	ks	-
28612	2 x 50 m	ks	-

BROWNTAX 160 g/m²

90%



Kód	rozmery	m. j.	kart.
28591	1 x 10 m	ks	6
28593	1,5 x 10 m	ks	6
28594	1,8 x 10 m	ks	6
28595	2 x 10 m	ks	6
28596	1 x 50 m	ks	-
28599	1,8 x 50 m	ks	-
28598	1,5 x 50 m	ks	-
28602	2 x 50 m	ks	-

BRIDFIX príchytky

NEW



Kód	farba	bal.	m. j.
28579	zelená	50 ks	bal.
285790	šedá	50 ks	bal.
285792	hnedá	50 ks	bal.
285794	čierna	50 ks	bal.

Úvaz - šnúra k tieniacim sieťam



Kód	bal.
283041	3 cm x 50 m

Plotové krycie pásy



Kód	rozmary	farba	hustota
285110	19 cm x 35 m	zelená	450 g/m ²

Kód	rozmary	farba	hustota
285120	19 cm x 35 m	antracit	450 g/m ²



Plotové tieniace pásy



Kód	rozmary	farba	hustota
285010	19 cm x 26 m	zelená	1200 g/m ²

Kód	rozmary	farba	hustota
285020	19 cm x 26 m	antracit	1200 g/m ²



Siete

Sieť proti vtákom



Kód	rozmery	oko	m. j.
19301	2 x 5 m	19 x 19 mm	ks
19303	2 x 10 m	19 x 19 mm	ks
19305	2 x 50 m	19 x 19 mm	ks
19302	4 x 5 m	19 x 19 mm	ks
19304	4 x 10 m	19 x 19 mm	ks
19306	4 x 50 m	19 x 19 mm	ks

Sieť podporná



Kód	rozmery	oko	m. j.
18010	1,2 x 10 m	10 x 10 cm	ks
18007	1,7 x 5 m	15 x 17 cm	ks
18012	1,7 x 10 m	15 x 17 cm	ks
18033	1,7 x 20 m	15 x 17 cm	ks
18400	1,7 x 100 m	15 x 17 cm	ks

Príchytky na fólie



Kód	balenie	m. j.
24000	20 ks	bal.

Vrecia

Vrece tkané 50 kg



Kód	rozmer	m. j.
28230	56 x 115 cm	bal.

Vrece PE 150 mic



Kód	rozmer	farba	m. j.
28870	400 x 600 mm	transparent	ks
28850	560 x 1100 mm	transparent	ks
28800	560 x 1100 mm	čierne	ks

Sieťovina paletizačná 5,7 kg



Kód	balenie	m. j.
289010	50 cm x 1500 m	ks

Big-Bag



Kód	balenie	m. j.
107070	70 x 70 x 70 cm	ks
109090	90 x 90 x 110 cm	ks

Špagát jutový



Kód	hustota /hrúbka	dĺžka	bal.
28339	100 g/1,25 mm	100 m	10 ks
28340	200 g/1,25 mm	200 m	10 ks
28341	500 g/1,75 mm	500 m	6 ks
28342	50 g/1,75 mm	33 m	42 ks
28343	100 g/1,75 mm	67 m	10 ks
28344	250 g/1,75 mm	166 m	8 ks
28351	200 g/3,5 mm	60 m	10 ks
28352	500 g/3,5 mm	150 m	6 ks
28353	1000 g/4 mm	300 m	4 ks

Špagát bavlna 40 g



Kód	hrúbka	dĺžka
28371	1,25 mm	63 m

Špagát lanový



Kód	hustota	dĺžka	bal.
28408	40 g	63 m	10 ks
28409	100 g	158 m	10 ks

Špagát PP



Kód	hustota /hrúbka	dĺžka	bal.	m. j.
28305	100 g/2 mm	124 m	10 ks	ks
28306	250 g/2 mm	310 m	8 ks	ks
28307	500 g/2 mm	620 m	6 ks	ks
28313	250 g/2,3 mm	200 m	8 ks	ks
28314	500 g/2,3 mm	400 m	6 ks	ks
28315	1000 g/2,3 mm	800 m	4 ks	ks

Špagát PP 5 kg



Kód	hrúbka	dĺžka	m. j.
28322	2,15 mm	5000 m	ks
28323	2,25 mm	4000 m	ks
28324	2,75 mm	3500 m	ks
28326	3,25 mm	2500 m	ks
28327	3,25 mm	2500 m	ks
28328	3,75 mm	2000 m	ks

Špagát



Kód	názov	bal.	m. j.
28304	špagát PP 50 g 2 mm 7800 tex	62 m	ks
283040	špagát PP 100 g 2 mm 7800 tex	124 m	ks

Lano polyamidové



Kód	balenie
999012	200 m

Plachta PE štandard 65g



Kód	rozmer
1260023	2 x 3 m
1260034	3 x 4 m
1260035	3 x 5 m
1260045	4 x 5 m
1260046	4 x 6 m
1260056	5 x 6 m
1260058	5 x 8 m
1260610	6 x 10 m
1260812	8 x 12 m

Flexibilný mäkký úväz pre rastliny



Kód	balenie
1503083	3,9 mm x 30 m

Bambusy, koly, úväzy

Lyko



Kód	hmotnosť
5022880	50 g
5022881	150 g

Jutenon pás



Kód	rozmer
366	10 cm x 25 m

Oporný kôl morený



Kód	popis	rozmer	bal.
9990016	Gulatý s hrotom	5/250 cm	100 ks/pal.
9990026	Gulatý s hrotom	6/250 cm	100 ks/pal.
9990036	Spájací Polo	6/250 cm	200 ks/pal.

Úväz - popruh čierny



Kód	rozmer
999010	25 mm x 50 m
999011	35 mm x 50 m

Bambusová tyč



Kód	rozmer	bal.
7509	6 - 8 mm/90 cm	500 ks/bal.
75091	6 - 8 mm/90 cm	20 ks/bal.
7512	8 - 10 mm/120 cm	500 ks/bal.
75121	8 - 10 mm/120 cm	20 ks/bal.
7515	10 - 12 mm/150 cm	250 ks/bal.
75151	10 - 12 mm/150 cm	10 ks/bal.
7518	12 - 144 mm/180 cm	200 ks/bal.
75181	12 - 144 mm/180 cm	10 ks/bal.
7524	18 - 20 mm/240 cm	100 ks/bal.
7529	20 - 22 mm/300 cm	50 ks/bal.
75210	24 - 26 mm/210 cm	50 ks/bal.
75240	26 - 28 mm/240 cm	50 ks/bal.

Oceľová záhradná tyč



Kód	rozmer	bal.
15029687	0,8 x 60 cm	100 ks/bal.
15029688	1,1 x 90 cm	100 ks/bal.
15029671	1,1 x 120 cm	10 ks/bal.
1502967	1,1 x 150 cm	10 ks/bal.
15029672	1,1 x 180 cm	10 ks/bal.
15029675	1,6 x 150 cm	10 ks/bal.
1502968	1,6 x 180 cm	10 ks/bal.
15029681	1,6 x 210 cm	10 ks/bal.
15029685	2,0 x 180 cm	10 ks/bal.
15029686	2,0 x 210 cm	10 ks/bal.
1502975	2,0 x 240 cm	10 ks/bal.

Záhradná tyč k rajčinám



Kód	popis
145044	1,8 m - špirálová 7 mm komaxit strieborná

Bambus štiepaný



Kód	rozmer
145410	1 x 5 m
145415	1,5 x 5 m
145420	2 x 5 m

Spojka 90° pre záhradné tyče



Kód	rozmer
1502985	11 mm
1502987	16 mm

Spojka nastaviteľná pre záhradné tyče



Kód	rozmer
1502995	11 mm
1502997	16 mm



Kód	popis
150024	Pišťoľ prúdnicová PowerJet

Kód	popis
150025	Rýchlospojka na 1" hadicu PowerJet
150026	Rýchlospojka na 3/4" hadicu PowerJet



Kód	popis
150028	Medzikus na 2 rýchlospojky PowerJet

Kód	popis
150029	Medzikus na 2 rýchlospojky PowerJet - Standard



Kód	popis
1500270	Adaptér na vodovodný kohút 3/4" PowerJet
1500271	Adaptér na vodovodný kohút 1" PowerJet

Kód	popis
150031	Adaptér PowerJet - závit 3/4" VOZ



Kód	popis
150027	Adaptér na ventil 3/4" - 1" PowerJet

Vodný program



Kód	popis
150033	Pišťoľ prúdnicová Standard



Kód	popis
150034	Rýchlospojka na 1/2" hadicu Standard
150035	Rýchlospojka na 3/4" hadicu Standard



Kód	popis
150036	Rýchlospojka stop na 1/2" hadicu Standard
150037	Rýchlospojka stop na 3/4" hadicu Standard



Kód	popis
150038	Rýchlospojka stop na 3/4" hadicu/3/4" VNZ



Kód	popis
150039	Rýchlospojka na 3/4" hadicu/3/4" VOZ



Kód	popis
150041	Adaptér na 1/2" hadicu/3/4" VOZ



Kód	popis
150043	Spojka na hadicu 1/2" - 1/2"
150045	Spojka na hadicu 3/4" - 3/4"
150046	Spojka na hadicu 1" - 1"



Kód	popis
150047	Redukovaná spojka na hadicu 1/2" - 3/4"
150048	Redukovaná spojka na hadicu 3/4" - 1"



Kód	popis
1500231	Rýchlospojka TPR 1/2" - 5/8"
1500232	Rýchlospojka TPR 3/4"
1500233	Rýchlospojka stop TPR 1/2" - 5/8"
1500234	Rýchlospojka stop TPR 3/4"



Kód	popis
1500230	Pišťoľ prúdnicová nastaviteľná TPR



Kód	popis
150051	Adaptér Standard - red. 1/2" - 3/4" VNZ
150052	Adaptér Standard - red. 3/4" - 1" VNZ



Kód	popis
150049	Klíbový adaptér Standard - 1" - 3/4" VNZ



Kód	popis
150053	Adaptér Standard - 1/2" VNZ
150054	Adaptér Standard - 3/4" VNZ
150056	Adaptér Standard - 1" VNZ'



Kód	popis
1500560	Medzikus - adaptér Standard - 1/2" VOZ
150057	Medzikus - adaptér Standard - 3/4" VOZ



Kód	popis
150058	Medzikus - adaptér Standard/Standard



Kód	popis
150059	Medzikus - adaptér pre 3 rýchlospojky Standard



Kód	popis
150061	Ventil - adaptér Standard - 3/4" VNZ



Kód	popis
150062	Ventil - adaptér 3/4" VOZ - 3/4" VNZ
150063	2x ventil - adaptér Standard - 3/4" VNZ



Kód	popis
1500730	Vodná pištoľ WL-EN54M regulovateľná



Kód	popis
1500731	Vodná pištoľ WL-EN55M 5-funkčná
1500732	Vodná pištoľ WL-EN56M 7-funkčná

Vodný program



Kód	popis
150068	Prietokomer, LCD displej, pracovný tlak 1 - 8 bar, max. 60°C voda, Standard



Kód	popis
150064	Rozdeľovací 4x ventil - adaptér Standard 1" - 3/4"VNZ



Kód	popis
150066	Sada 1/2" - pištoľ, 2x rýchlospojka, adaptér Standard - 1/2" - 3/4"VNZ



Kód	popis
150067	Sada 3/4" - pištoľ, 2x rýchlospojka, adaptér Standard - 3/4" - 1"VNZ



Kód	popis
150073	Sada tesnení 1/2", 3/4", 1" Standard O-ring, 6 ks v bal.



Kód	popis
150074	Vodná pištoľ kovová WATER CLICK nastaviteľná, Standard



Kód	popis
150076	Vodná pištoľ kovová WATER CLICK 5-funkčná, Standard



Kód	popis
150077	Vodná pištoľ kovová WATER CLICK 7-funkčná, Standard



Kód	popis
1500712	Časovač prietoku vody 3/4" - 1"



Kód	popis
150072	Tesnenie 3/4" s filtrom



Kód	popis
1500774	Vodná pištoľ regulovateľná jednoduchá



Kód	popis
150078	Vodná pištoľ 5-funkčná QuickMultiSpray



Kód	popis
150079	Vodná pištoľ nastaviteľná Quick jednoduchá



Kód	popis
1500801	Vodná pištoľ multifunkčná Quick Exclusive



Kód	popis
15008582	Nastaviteľný prúdnicový postrekovač s ventilom TPR



Kód	popis
1500804	Postrekovač pulzný regulovateľný, priemer postreku 15 m



Kód	popis
15008581	Pulzný postrekovač Aqua Jet dostrek 14 - 28 m



Kód	popis
1500803	Postrekovač pulzný bez regulácie, priemer postreku 27 m



Kód	popis
1502958	Záhradný ventil dvojcestný M 1/2", 2x M 3/4"



Kód	popis
1502959	Záhradný ventil dvojcestný M 3/4", 2x M 1"

Vodný program



Kód	popis
150081	Postrekovač stacionárny 8 funkčný, Standard



Kód	popis
150083	Postrekovač výkyvný, 18 trysiek, pokrytie 375 m ² , Standard



Kód	popis
150082	Postrekovač rotačný 3 ramenný, Standard



Kód	popis
150084	Postrekovač výkyvný, plast/hliník, 18 trysiek, 334 m ² , Standard



Kód	popis
1500822	Postrekovač rotačný na podstavci, 4-funkčný, regulovateľný, priemer dostreku d 21 m



Kód	popis
1500845	Postrekovač pulzný Triton, trojšpic, plast, priemer dostreku d 26,6 m



Kód	popis
1500842	Postrekovač pulzný regulovateľný, kovový špic, priemer dostreku d 26,2 m



Kód	popis
150650	Trojnožka nastaviteľná 57 - 90 cm s postrekovačom, dostrek 13,5 m



Kód	popis
150660	Trojnožka nastaviteľná 75 - 110 cm, závit ¾" vonk.
150670	Trojnožka nastaviteľná 75 - 110 cm, závit 1" vonk.



Kód	popis
1500853	Postrekovač na tyči s ventilom regulácie prietoku, sitko Pro



Kód	popis
1500847	Postrekovač regulovateľný, špic plast, priemer dostreku d 10 m



Kód	popis
1500858	Postrekovač tyčový, kovový s ventilom, sitko, 90 cm/1 mm



Kód	popis
1500852	Postrekovač na tyči s ventilom regulácie prietoku, sitko Exclusive



Kód	popis
1506040	Geka spojka, IMT zátka, Standard



Kód	popis
1506011	Geka spojka IMT 1/2" - 13 mm hadicová
1506013	Geka spojka IMT 3/4" - 19 mm hadicová
1506014	Geka spojka IMT 1" - 25 mm hadicová
1506016	Geka spojka IMT 1 1/4" - 32 mm hadicová



Kód	popis
1506021	Geka spojka IMT 1/2" vnútorný závit
1506023	Geka spojka IMT 3/4" vnútorný závit
1506024	Geka spojka IMT 1" vnútorný závit
1506026	Geka spojka IMT 1 1/4" vnútorný závit



Kód	popis
1506031	Geka spojka IMT 1/2" vonkajší závit
1506033	Geka spojka IMT 3/4" vonkajší závit
1506034	Geka spojka IMT 1" vonkajší závit
1506036	Geka spojka IMT 1 1/4" vonkajší závit



Kód	popis
1506050	Geka spojka IMT T-kus Standard



Kód	popis
1506060	Tesnenie pre gecka spojky IMT Standard



Kód	popis
150752	BR-2120 rýchlospojka na 1/2" hadicu
150754	BR-2130 rýchlospojka na 3/4" hadicu



Kód	popis
150756	BR-2196 adaptér 1/2"
150758	BR-2195 adaptér 3/4"
150760	BR-2197 adaptér 1"



Kód	popis
150764	BR-2200 medzikus - adaptér



Kód	popis
150772	BR-2185 medzikus - adaptér 3/4"



Kód	popis
150762	BR-2134 rotačný adaptér L 3/4"



Kód	popis
150766	BR-2012 spojka na hadicu 1/2"
150768	BR-2058 spojka na hadicu 5/8"
150770	BR-2034 spojka na hadicu 3/4"



Kód	popis
150774	BR-2234 2x ventil 3/4" VOZ - 3/4" VNZ



Kód	popis
150750	BR-4710 pištoľ prúdnicová



Kód	popis
145223	Hadicová koncovka ½" hollander
145224	Hadicová koncovka ¾" hollander
145225	Hadicová koncovka 1" hollander

Kód	popis
145220	Hadicová spojka ½" hollander
145221	Hadicová spojka ¾" hollander
145222	Hadicová spojka 1" hollander



Kód	popis
145229	Rozprašovač ½" - ¾"

Kód	popis
145226	Hadicová redukcia ¾" - ½" hollander
145227	Hadicová redukcia 1" - ¾" hollander
145228	Hadicová redukcia 1" - ½" hollander



Kód	popis
145622	Hadicová spona 12 - 20 mm NEREZ
145623	Hadicová spona 16 - 25 mm NEREZ
145624	Hadicová spona 20 - 32 mm NEREZ
145625	Hadicová spona 25 - 40 mm NEREZ
145626	Hadicová spona 30 - 45 mm NEREZ
145627	Hadicová spona 32 - 50 mm NEREZ

Kód	popis
145615	Hadicová spona 110 - 130 mm
145619	Hadicová spona 150 - 170 mm

Okrasné umývadlá a studne

VERONA - nástenné umývadlo + kohútik 1/2"
Rozmery: 66 x 39 x 24 cm



Kód	farba
95000	zeleno/biela
95010	zelená
95015	biela
95020	čierna
95030	antické zlato
95032	antické striebro
95040	granit
95050	antický bronz
95060	kameň
95070	kladivkový bronz
95080	kladivkové striebro
95090	antická zelená

 **LEN NA OBJEDNÁVKU**

FIRENZE - studňa + kohútik 3/4"
Rozmery: 89 x 48 x 32 cm



 **LEN NA OBJEDNÁVKU**

Kód	farba
95210	zelená
95220	kladivkové striebro
95230	antický bronz
95235	antické striebro
95240	kladivkový bronz
95250	čierna
95260	kameň
95270	kladivkové zlato

VIENNA - nástenné umývadlo + kohútik 1/2"
Rozmery: 83 x 47 x 26 cm



 **LEN NA OBJEDNÁVKU**

Kód	farba
95100	zeleno/biela
95110	zelená
95120	čierna
95130	antické zlato
95135	antické striebro
95140	granit
95150	antický bronz
95160	kameň

ROMA - studňa + kohútik 1/2"
Rozmery: 98 x 32 x 48 cm



 **LEN NA OBJEDNÁVKU**

Kód	farba
95600	biela
95610	zelená
95620	čierna
95625	kladivkové striebro
95630	antické zlato
95632	antické striebro
95635	granit
95637	kladivkový bronz
95638	kladivkové zlato
95640	antický bronz
95645	antik zelená
95650	kameň
95660	granit

SIENA - nástenné umývadlo + kohútik 1/2"
Rozmery: 83 x 51 x 36 cm



 **LEN NA OBJEDNÁVKU**

Kód	farba
95200	antické zlato
95690	antické striebro

PISA - studňa + kohútik 1/2"
Rozmery: 89 x 32 x 48 cm



 **LEN NA OBJEDNÁVKU**

Kód	farba
95665	čierna
95666	antické zlato
95667	kladivkový bronz
95668	antický bronz



TRIANGLE



Kód	farba
00400B	bronz
00400G	šedá
00400V	zelená

TOTEM



Kód	farba
00407G	šedá
00407N	matná čierna
00407R	korálovo-červená

LOOP



Kód	farba
00409B	biela
00409C	hrdzavo-hnedá
00409VS	pastelovo-zelená



Studňa kovová



Kód	farba
95750	antik
95760	čierna
95770	sivá
95780	strieborná

Držiak - kotvenie pre studne
série 400 - 407 - 409



Kód	popis
000135	držiak pre kotvenie

Ventily



Kód	popis	pripojenie	m. j.
93010	mosadz	1/2"	ks



Kód	popis	pripojenie	m. j.
93011	mosadz	1/2"	ks



Kód	popis	pripojenie	m. j.
93012	mosadz	1/2"	ks



Kód	popis	pripojenie	m. j.
93013	chróm	3/4"	ks



Kód	popis	pripojenie	m. j.
93014	mosadz	3/4"	ks



Kód	popis	pripojenie	m. j.
93020	čierna/bronzová	1/2"	ks



Kód	popis	pripojenie	m. j.
93022	čierna/strieborná	1/2"	ks



Kód	popis	pripojenie	m. j.
93026	čierna/zelená	1/2"	ks

Záhradná hadica Fitt žltá

Kód	priemer	dĺžka	m. j.
154801	1/2"	25 bm	ks
154802	3/4"	25 bm	ks
154803	1"	25 bm	ks

Záhradná hadica SUN

Kód	priemer	dĺžka	m. j.
154821	1/2"	25 bm	ks
154822	3/4"	25 bm	ks

Záhradná hadica Fitt modrá

 nárazový tlak **25 - 30 bar**

Kód	priemer	dĺžka	m. j.
154811	1/2"	25 bm	ks
154812	3/4"	25 bm	ks
154813	1"	25 bm	ks
154815	1/2"	50 bm	ks
154816	3/4"	50 bm	ks

Zavlažovací vak

- Vak vyrobený s odolného PE, max. objem vody 85 l
- Zipsom je možné spojiť dva vaky, v tom prípade je max. objem 100 l
- Doba vykvákavania 5 hod

Kód	objem
1503160	85 l

Samonavíjací box s hadicou WL

Kód	pripojenie	dĺžka	m. j.
15029420	1/2"	20 m	ks
15029435	1/2"	35 m	ks

Vozík na hadicu SOLID ZINC CHROM

Kód	pripojenie	dĺžka	m. j.
1502901	3/4"	50 m	ks

Vozík na hadicu AQUA REEL

Kód	pripojenie	dĺžka	m. j.
150292	1/2"	45 m	ks

Držiak nástenný kovový ECO WF114

Kód	m. j.
150301	ks

**PRIPRAVUJEME NOVÉ TYPY
HADÍC NA ROK 2024**

Osviežovače a zavlažovacie sety

Osviežujúci set



Kód	rozmer	m. j.
95806	15 m	ks
95810	náhradná hadička	ks
95820	náhradné trysky	ks
95830	Osviežujúci set 7,5 m	ks
95840	Osviežujúci set 15 m	ks

Osviežujúci set



- 4+1 trysky s ohybným kĺbom
- Vodnou parou chladí vzduch až o 10 °C.

Kód	rozmer	m. j.
95830	7,5 m	ks
95840	15 m	ks

Časový spínač



Kód	pripojenie	m. j.
95808	1" a ¾"	ks

Zavlažovací set WATER FLOW DRIP

50 m hadica



Kód	m. j.
1503100	ks

Zavlažovací set MÔJ BALKÓN

15 m hadica



Kód	m. j.
352055	ks

Zavlažovací set ZELENINOVÁ ZÁHRADA

25 m hadica



Kód	m. j.
352057	ks

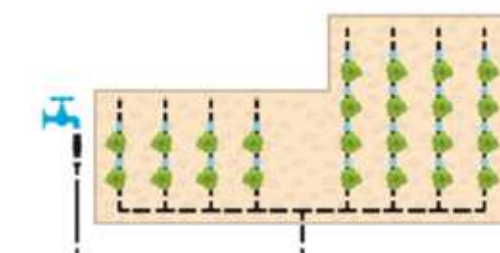



Kód	popis
1001615	kruh (round) 1,6 mm/15 m
10020100	kruh (round) 2,0 mm/100 m
1002015	kruh (round) 2,0 mm/15 m
10024100	kruh (round) 2,4 mm/100 m
1002415	kruh (round) 2,4 mm/15 m
10024481	kruh (round) 2,4 mm/481 m
10027100	kruh (round) 2,7 mm/100 m
1002715	kruh (round) 2,7 mm/15 m
10027380	kruh (round) 2,7 mm/380 m
10030100	kruh (round) 3,0 mm/100 m
1003015	kruh (round) 3,0 mm/15 m
10030308	kruh (round) 3,0 mm/308 m



Kód	popis
1021615	hviezda (star) 1,6 mm/15 m
10220100	hviezda (star) 2,0 mm/100 m
1022015	hviezda (star) 2,0 mm/15 m
10224100	hviezda (star) 2,4 mm/100 m
1022415	hviezda (star) 2,4 mm/15 m
10224641	hviezda (star) 2,4 mm/641 m
10227100	hviezda (star) 2,7 mm/100 m
1022715	hviezda (star) 2,7 mm/15 m
10227507	hviezda (star) 2,7 mm/507 m
10230100	hviezda (star) 3,0 mm/100 m
1023015	hviezda (star) 3,0 mm/15 m
10230410	hviezda (star) 3,0 mm/410 m

Kód	popis
1011615	štvorec (square) 1,6 mm/15 m
10120100	štvorec (square) 2,0 mm/100 m
1012015	štvorec (square) 2,0 mm/15 m
10124100	štvorec (square) 2,4 mm/100 m
1012415	štvorec (square) 2,4 mm/15 m
10124437	štvorec (square) 2,4 mm/437 m
10127100	štvorec (square) 2,7 mm/100 m
1012715	štvorec (square) 2,7 mm/15 m
10127345	štvorec (square) 2,7 mm/345 m
10130100	štvorec (square) 3,0 mm/100 m
1013015	štvorec (square) 3,0 mm/15 m
10130280	štvorec (square) 3,0 mm/280 m

QuickFit

FISKARS®



Kód	popis
31000687	Nôž na špáry

Kód	popis
3130000	Univerzálny adaptér



Kód	popis
31000659	Hrable QuikFit na lístie úzke

Kód	popis
3135013	Hrable široké na lístie



Kód	popis
31000660	Hrable na lístie ľahké (L)

Kód	popis
31000643	Hrable QuikFit univerzálne



Kód	popis
3135512	Hrable (16 hrotov)

Kód	popis
3135513	Hrable prevzdušňovacie



Kód	popis
3135514	Hrable široké 58 cm

Kód	popis
3135533	Metla na terasy QuikFit

QuickFit

FISKARS®



Kód	popis
3136001	Násada Graphite



Kód	popis
3136032	Násada teleskopická Graphite (L)



Kód	popis
3136042	Násada teleskopická (M)



Kód	popis
3136503	Motyčka



Kód	popis
3136525	Univerzálne nožnice



Kód	popis
3136527	Píla prerezávacía zahnutá

Sekery



Kód	popis
31015617	Sekera X5 XS



Kód	popis
31015618	Sekera X7 XS



Kód	popis
31015619	X10 S

Náradie FISKARS

FISKARS®



Kód	popis
31003685	Vidly Xact veľké



Kód	popis
31001579	Lopata Ergonomic



Kód	popis
3131400	Rýľ Ergonomic, rovný



Kód	popis
3131410	Rýľ Ergonomic, špicatý



Kód	popis
3136500	Motyka ľahká



Kód	popis
3135510	Hrable ľahké záhradné

Záhradné nožnice



Kód	popis
145029	Nožnice NEREZ, aluminium



Kód	popis
145095	Záhradné nožnice WINLAND 20 cm 3130 TW



Kód	popis
145098	Záhradné nožnice WINLAND 22 cm japonská oceľ



Kód	popis
145099	Záhradné nožnice WINLAND 19 cm japonská oceľ

Záhradné nožnice



Kód	popis
145000	Nožnice PROFI na konáre oblé 75 cm
145001	Nožnice PROFI na konáre oblé 71 cm



Kód	popis
145005	Nožnice PROFI prevodové 58 cm vlnité ostrie 23 cm
145006	Nožnice PROFI prevodové 58 cm rovné ostrie 23 cm



Kód	popis
145009	Nožnice HOBBY vlnité ostrie 51 cm



Kód	popis
145011	Nožnice na trávku pevné 30 cm



Kód	popis
145012	Nožnice na trávku otočné 180° 37 cm



Kód	popis
145015	Nožnice pružinové rovné



Kód	popis
145016	Nožnice pružinové oblé



Kód	popis
145018	Záhradné nožnice kované



Kód	popis
145025	Nožnice PROFI hliník s aretáciou 20 cm



Kód	popis
145027	Nožnice PROFI kov s rohatkou

Nožnice Felco



Kód	popis
12512	Nožnice záhradnícke Felco 7



Kód	popis
12510	Nožnice záhradnícke Felco 8



Kód	popis
12515	Nožnice záhradnícke Felco 6



Kód	popis
12516	Nožnice záhradnícke Felco 13



Kód	popis
12520	Nožnice záhradnícke Felco 11



Kód	popis
12521	Nožnice záhradnícke Felco 2



Kód	popis
12525	Nožnice záhradnícke Felco 9 pre ľavákov



Kód	popis
125251	Nožnice záhradnícke Felco 160S



Kód	popis
125250	Nožnice záhradnícke Felco 160L



Kód	popis
125292	Puzdro pravá koža - kónické FELCO 912

Puzdra Felco, nožnice Archman



Kód	popis
125290	Puzdro umelá koža - kónické FELCO 913

Kód	popis
125291	Puzdro pravá koža - FELCO 910

Nožnice záhradnícke Archman



Kód	popis
12530	art. 1

Kód	popis
12540	art. 10

Kód	popis
12560	art. 4

Náradie Truper



Kód	popis
3130005	Hrable - hliníkové s tepelnou úpravou, 760 mm šírka, 168 cm rúčka

Kód	popis
3130010	Hrable - hliníkové s tepelnou úpravou, 914 mm šírka, 208 cm rúčka



Kód	popis
3130020	Rýľ úzky, 14 x 41 cm, 76,5 cm sklolaminát rúčka

Kód	popis
3130040	Lopata - ryhovač 10 cm šírka, 122 cm sklolaminát rúčka



Kód	popis
3130090	Ručný bager/kliešťové rýpadlo, 15,3 x 23 cm, 122 cm sklolaminát rúčka

Kód	popis
3130080	Rýľ mini, 46 cm rúčka

Náradie FISKARS

FISKARS®



Kód	popis
3100613	Pílka Xtract malá



Kód	popis
3123880	Pílka Xtract veľká



Kód	popis
3120740	Ostrič nožov a sekier Xsharp



Kód	popis
3125880	Žabka záhradnícka



Kód	popis
3125900	Nôž očkovací



Kód	popis
31000726	Lopatka Fiskars Premium



Kód	popis
31000727	Lopatka Fiskars Premium na presádzanie



Kód	popis
31000728	Kultivátor Fiskars Premium



Kód	popis
31001733	Krompáč záhradný 200 ErgoComfort



Kód	popis
31020126	Vytrhávač buriny Xact

Záhradné nožnice a príslušenstvo FISKARS



Kód	popis
31000583	Nožnice PowerGear Steel na silné konáre LX94 (M), dvojčepelové

FISKARS®



Kód	popis
31000809	Nožnice univerzálne profi Cuts&More



Kód	popis
31001550	Nožnice PowerGear na silné konáre prevodové, jednočepelové (M)



Kód	popis
31001723	ND čepeľ k nožniciam č. 112590, 112370 a 112470



Kód	popis
31019197	Nožnice univerzálne veľké 21 cm čierne



Kód	popis
3111960	Nožnice záhradné profesionálne



Kód	popis
3114770	Nožnice na živý plot HSX92



Kód	popis
31013565	Nožnice SmartFit na živý plot, teleskopické HS86

Náradie



Kód	popis
112130	Pásmo sklolaminátové 30 m (púzdro)



Kód	popis
116034	Odlamovací nôž FESTA 25 mm SX2500 N



Kód	popis
116218	Nôž vrubľovací



Kód	popis
116219	Nôž očkovací



Kód	popis
116220	Nôž štepársky



Kód	popis
123014	Silonové lano 8 mm x cca 40 - 50 m biele



Kód	popis
123950	Viazacia páska 120 x 2,5 mm, 50 ks, čierna
123951	Viazacia páska 200 x 3,6 mm, 50 ks, čierna
123952	Viazacia páska 250 x 3,6 mm, 50 ks, čierna



Kód	popis
138944	Varovacia páska 250M ZÁKAZ VSTUPU

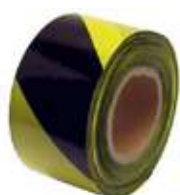

Kód	popis
138946	Varovacia páska 250M čierna-žltá



Kód	popis
142210	Viazací drôt 1,0 mm x 100 m pozinkovaný
142214	Viazací drôt 1,4 mm x 50 m pozinkovaný



Kód	popis
145043	Viazací drôt 30 m zelený



Kód	popis
142244	Viazací drôt 1,4 mm x 50 m zelený



Kód	popis
1502970	Podložka pod koleno 40 x 20 x 2 cm



Kód	popis
139165	Murárska nádoba obdĺžniková 65 l 64 x 33 x 27 cm
139190	Murárska nádoba obdĺžniková 80 l 70 x 40 x 28 cm



Kód	popis
139045	Murárska nádoba kruhová 45 l
139065	Murárska nádoba kruhová 65 l
139090	Murárska nádoba kruhová 90 l

Rukavice



Kód	popis	velkosť
438362	polyuretan Pure Gray	8"
438364	polyuretan Pure Gray	10"



Kód	popis	velkosť
438304	guma Nitrox mint	8"



Kód	popis	velkosť
438182	latex Perfect Grip	8"
438186	latex Perfect Grip	10"
438188	latex Perfect Grip	11"



Kód	popis	velkosť
438220	latex Classic plus	9"
438222	latex Classic plus	10"
438224	latex Classic plus	11"



Kód	popis	velkosť
438240	guma Nitrox	8"
438242	guma Nitrox	10"
438244	guma Nitrox	11"



Kód	popis	velkosť
438280	Nitrox Flowers	6"
438284	Nitrox Flowers	8"



Kód	popis	velkosť
438120	Orange Latex	2"
438122	Orange Latex	3"
438124	Orange Latex	4"
438126	Orange Latex	5"
438128	Orange Latex	6"



Kód	popis	velkosť
438140	Kitty	4"



Kód	popis	velkosť
438250	Grizzly - zimné	10"
438252	Grizzly - zimné	11"



Kód	popis	velkosť
438380	VERDE	9"
438382	VERDE	10"



Kód	popis	velkosť
919908	BONASIA FH CUT 3 PU 15 g	8"
919909	BONASIA FH CUT 3 PU 15 g	9"
919910	BONASIA FH CUT 3 PU 15 g	10"
919911	BONASIA FH CUT 3 PU 15 g	11"



Kód	popis	velkosť
339909	CORAX FH kombinované	9"
339912	CORAX FH kombinované	11"
339913	CORAX FH kombinované	10"

Rukavice



Kód	popis	velkosť
2999100	Rukavice PALAWAN s blistrom	10"
2999101	Rukavice PALAWAN s blistrom	9"



Kód	popis	velkosť
809909	EPOPS FH kombinované	9"
809910	EPOPS FH kombinované	10"
809911	EPOPS FH kombinované	11"



Kód	popis	velkosť
8587070	PINTAIL plet. nylon hnedá/zelená	7"
8587080	PINTAIL plet. nylon hnedá/zelená	8"
8587090	PINTAIL plet. nylon hnedá/zelená	9"



Kód	popis	velkosť
853907	PINTAIL plet. nylon navy/sv. fialová	7"
853908	PINTAIL plet. nylon navy/sv. fialová	8"



Kód	popis	velkosť
329909	TETRAX FH nylon. latex	9"
329910	TETRAX FH nylon. latex	10"
329911	TETRAX FH nylon. latex	11"



Kód	popis	velkosť
299836	Návlek POCHARD na ruku, kevlar	36 cm
299856	Návlek POCHARD na ruku, kevlar	56 cm

ZÁHRADNÉ OSVETLENIE 12V

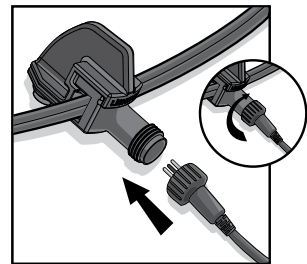
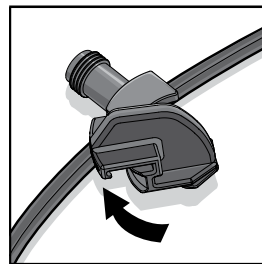
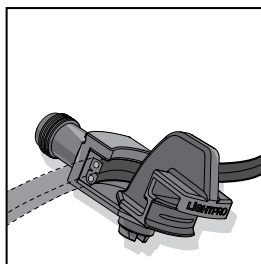
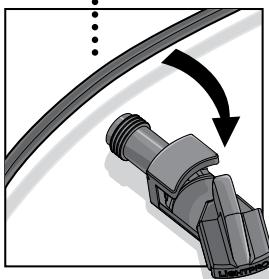
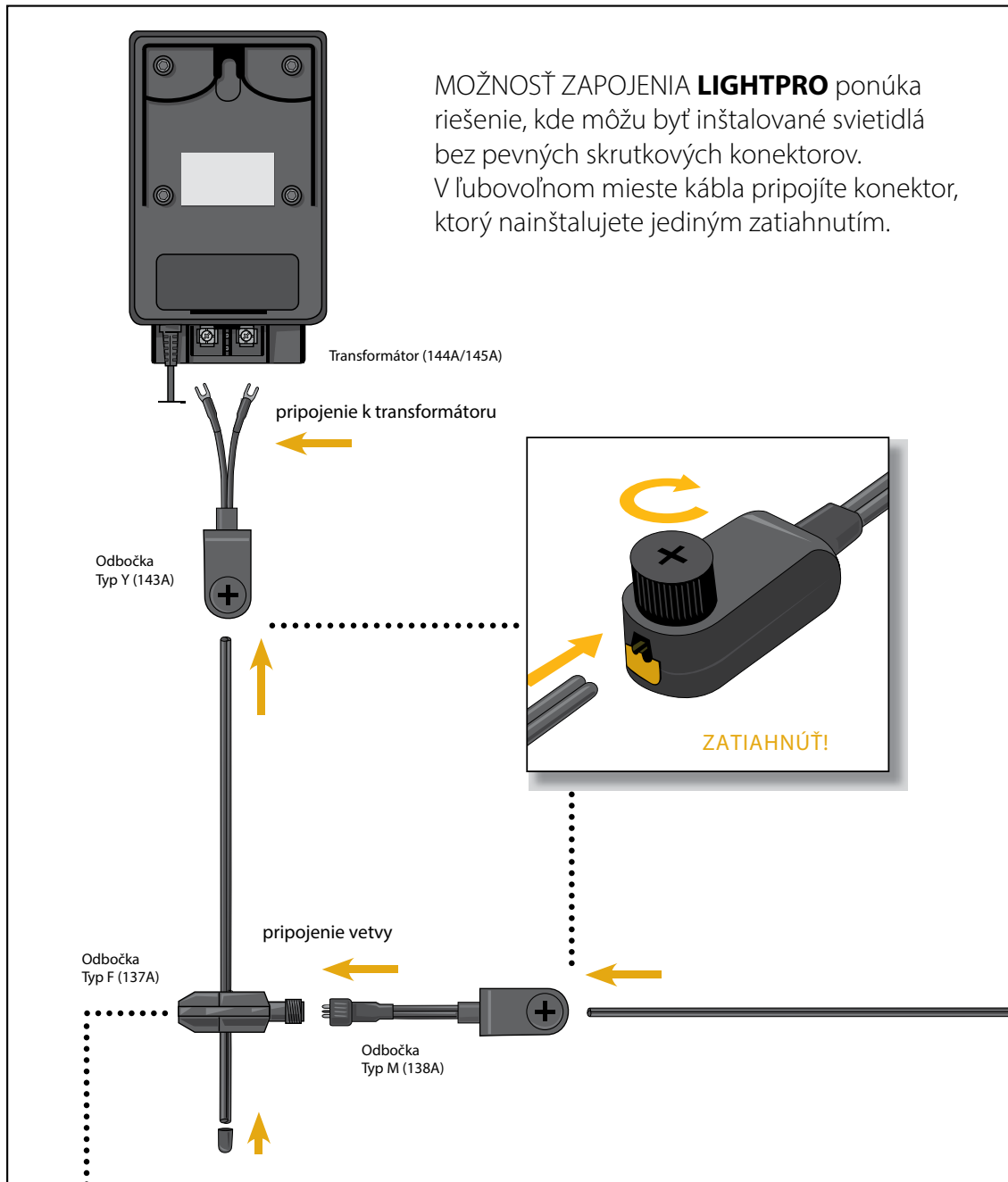
Zapojenie **LIGHTPRO**

OTOČIŤ A PRIPOJIŤ!

Zapojenie **Garden Lights**

System **Garden Lights** ponúka jednoduché riešenie zapojenia komponentov s dodávaným káblom a zástrčkou so skrutkovým konektorom odolným proti striekajúcej vode pevne pripojeným na káblu.

2. VÝBER TRANSFORMÁTORA

Celkový príkon zvoleného osvetlenia určuje požadovaný výkon transformátora. Sčítajte počet wattov svietidiel a príslušenstva. Potom si môžete zvoliť 24, 60 alebo 150 W transformátor.

Tip: Ak sa v budúcnosti rozhodnete pridať svetlo alebo príslušenstvo, vždy si ponechajte rezervu z hľadiska príkonu.

1. VÝBER SVIETIDLA

V rámci našej širokej ponuky produktov si vyberiete prvky, ktorými chcete atraktívne osvetliť vašu záhradu, príjazdovú cestu, plot alebo rybník.

3. VÝBER KÁBLA

Môžete si vybrať hlavný kábel s fixnými konektormi, hlavný kábel bez konektorov alebo predlžovací kábel. Predlžovací kábel s označením SPT-1W môžete použiť max. do 60 W. Káble s označením SPT-3W do 150 W.



Všetky svietidlá majú izolačný štandard minimálne IP 44, ak nie je uvedené inak. IP 44 Ochrana proti striekajúcej vode vo všetkých smeroch.



Arco 40 Plus SMART



Kód	popis
180645S	410 x 65 mm (v x š) LED 5 W RGB

Arco 40



Kód	popis
180645	405 x 64 mm (v x š), hliník LED 2,6 W teplá biela

Arco 60



Kód	popis
180650	573 x 64 mm (v x š), hliník LED 2,6 W teplá biela

Larix



Kód	popis
180107	315 x 100 mm (v x š) LED 1,1 W teplá biela



Laurus

Kód	popis
180112	365 x 120 mm (v x š) LED 1,1 W teplá biela

Nepos



Kód	popis
180312	400 x 110 mm (v x š) LED 2,6 W teplá biela



Titan

Kód	popis
180327	600 x 110 mm (v x š) LED 2,6 W teplá biela

Phobos



Kód	popis
180330	400 x 110 mm (v x š) LED 1,5 W biela



Kolossos

Kód	popis
180345	600 x 110 mm (v x š) LED 1,5 W biela



Locos

Kód	popis
180195	530 x 120 mm (v x š) LED 1,1 W teplá biela



Osvetlenie stĺpikové



Limosa 70

Kód	popis
180241	680 x 120 mm (v x š) LED 3,5 W teplá biela



Limosa 90

Kód	popis
180242	880 x 120 mm (v x š) LED 3,5 W teplá biela



SET

Oak SET

Kód	popis
180031	202 x 48 mm (v x š) LED 1 W teplá biela



Atila

Kód	popis
180395	610 x 60 mm (v x š) LED 1,5 W teplá biela



Albus

Kód	popis
180390	410 x 60 mm (v x š) LED 1,5 W teplá biela



Linum

Kód	popis
180115	160 x 60 mm (v x š) LED 2 W teplá biela



Silia

Kód	popis
180061	600 x 60 mm (v x š) LED 1 W teplá biela



Rune

Kód	popis
180059	555 x 127 mm (v x š) LED 1,8 W teplá biela



Lunia



Kód	popis
180053	440 x 60 mm (v x š) LED 1 W



Lunia SET

SET



Kód	popis
180054	440 x 60 mm (v x š) LED 1 W



Možnosť prepínania:
biela / studená biela



LEN NA
OBJEDNÁVKU



Deva



Kód	popis
180043	457 x 105 mm (v x š) LED 1,8 W



Dax

Kód	popis
180042	780 x 160 mm (v x š) LED 1,8 W teplá biela



Ceto



Kód	popis
180041	440 x 190 mm (v x š) LED 2 W teplá biela



Atera

Kód	popis
180038	617 x 105 mm (v x š) LED 1,8 W teplá biela



Barite 40

Kód	popis
180500	405 x 65 mm (v x š) LED 2,6 W teplá biela



Barite 60



Kód	popis
180350	575 x 65 mm (v x š) LED 2,6 W teplá biela



Eros Lo

Kód	popis
180661	500 x 115 mm (v x š) LED 3,5 W teplá biela



Eros Hi

Kód	popis
180662	870 x 115 mm (v x š) LED 3,5 W teplá biela



Nodin

Kód	popis
180460	1020 x 105 mm (v x š) LED 2,6 W teplá biela



Alon

Kód	popis
180004	700 x 160 mm (v x š) LED 3,3 W teplá biela



Možnosť prepínania:
biela / studená biela



LEN NA
OBJEDNÁVKU

Osvetlenie stípkové



Oberon Smart



Kód	popis
180008	665 x 64 mm (v x š) LED 4,9 W RGB



Oberon Hi

Kód	popis
180007	665 x 64 mm (v x š) LED 4 W teplá biela



Oberon Lo

Kód	popis
180006	420 x 64 mm (v x š) LED 4 W teplá biela



Oberon DL

Kód	popis
180680	600 x 110 mm (v x š) LED 9 W teplá biela



Erba

Kód	popis
180002	905 x 20 mm (v x š) LED 1,1 W teplá biela



Erba Mid

Kód	popis
180003	734 x 20 mm (v x š) LED 1,1 W teplá biela

Focus Plus SMART



Kód	popis
180152S	180 x 150 (v x š) LED 5 W RGB

Focus



Kód	popis
180152	180 x 80 mm (v x š) LED 2,6 W teplá biela

Arcus Plus SMART



Kód	popis
180297S	145 x 105 (v x š) LED 5 W RGB

Arcus



Kód	popis
180297	120 x 60 mm (v x š) LED 5 W teplá biela

Arigo



Kód	popis
180362	125 x 90 mm (v x š) LED 2,6 W teplá biela

Protego



Kód	popis
180507	140 x 120 mm (v x š) LED 5 W teplá biela

Flood 12



Kód	popis
180600	150 x 154 mm (v x š) LED 12 W teplá biela

Flood 20



Kód	popis
180601	150 x 154 mm (v x š) LED 20 W teplá biela

Cylon



Kód	popis
180605	100 x 100 mm (v x š) LED 2,6 W teplá biela

Neso



Kód	popis
2606061	220 x 70 mm (v x š) LED 2 W teplá biela

Bodové svetlá

Alder



Kód	popis
180000	120 x 40 mm (v x š) Power LED 1,8 W teplá biela

Alder SET



SET

Kód	popis
180005	120 x 40 mm (v x š) Power LED 1,8 W teplá biela

Catalpa



Kód	popis
180040	120 x 80 mm (v x š) Power LED 2,6 W teplá biela

Catalpa SET



SET

Kód	popis
180046	120 x 80 mm (v x š) Power LED 2,6 W teplá biela

Lapis

IP67



Kód	popis
180302	110 x 145 mm (v x š) LED 2,6 W teplá biela

Lapis SET

IP67



SET

Kód	popis
180307	110 x 145 mm (v x š) LED 2,6 W teplá biela

Corvus



Kód	popis
180245	210 x 89 mm (v x š) LED 5 W teplá biela

Raf



Kód	popis
180058	139 x 95 (v x š) LED 1,8 W teplá biela

Lovi



Kód	popis
180052	122 x 58 (v x š) LED 1,8 W teplá biela

Minus



Kód	popis
180230	70 x 45 mm (v x š) LED 2 W teplá biela

Castor SMART



Kód	popis
180014	95 x 120 mm (v x š) LED 4,9 W RGB

Castor 3



Kód	popis
180013	95 x 100 mm (v x š) LED 2,5 W teplá biela

Castor 4



Kód	popis
180850	95 x 60 (v x š) LED 3,5 W teplá biela

Castor 8



Kód	popis
180855	95 x 60 (v x š) LED 8 W teplá biela

Castor 9



Kód	popis
180856	95 x 60 (v x š) LED 9 W teplá biela



Kryt na Castor 8, 9

Kód	popis
180857	Kryt na Castor 8, 9

Nova 3



Kód	popis
180485	115 x 81 mm (v x š) LED 3 W teplá biela



Nilus



Kód	popis
180027	135 x 110 (v x š) LED 3,4 W teplá biela

Quartz



Kód	popis
180024	105 x 88 mm (v x š) LED 1,8 W teplá biela



Avior

Kód	popis
180026	15 x 68 (v x š) LED 16 W teplá biela



Stmievateľné osvetlenie



Bodové svetlá

Juno 2



Kód	popis
180022	85 x 68 mm (v x š) LED 1,5 W teplá biela

Juno 4

IP65



Kód	popis
180023	85 x 68 mm (v x š) LED 4 W teplá biela

Juno Tube

IP65





Kód	popis
180001	85 x 68 (v x š) LED 4 W teplá biela

Xible

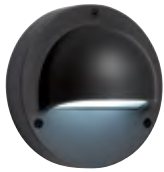

Kód	popis
180009	695 x 36 mm (v x š) LED 2 W teplá biela

Deimos antracit



Kód	popis
180225	140 x 140 mm (v x š) LED 1,5 W teplá biela

Deimos čierny **Garden Lights**



Kód	popis
180276	140 x 140 mm (v x š) LED 1,5 W teplá biela

Aurora



Kód	popis
180101	100 x 100 mm (v x š) LED 3 W teplá biela

Callisto



Kód	popis
180220	240 x 170 mm (v x š) LED 1,1 W teplá biela

Celata



Kód	popis
180238	380 x 190 mm (v x š) LED 3,5 W teplá biela

Columba



Kód	popis
180237	450 x 220 mm (v x š) LED 3,5 W teplá biela

Mauri Anthracite



Kód	popis
180228	100 x 100 mm (v x š) LED 6 W

Mauri Black



Kód	popis
180224	100 x 100 mm (v x š) LED 6 W

Goura Anthracite



Kód	popis
180227	100 x 140 mm (v x š) LED 6 W

Goura Black



Kód	popis
180226	100 x 140 mm (v x š) LED 6 W



Zmena uhlu vyžarovania nahor a nadol



LEN NA OBJEDNÁVKU

Nástenné svetlá

Gilvus Plus



Kód	popis
180062	80 x 92 mm (v x š) LED 5 W RGB

Gilvus Plus SET



Kód	popis
180063	80 x 92 mm (v x š) LED 5 W RGB

Gilvus Anthracite



Kód	popis
180231	92 x 67 mm (v x š) LED 4 W teplá biela

Gilvus Black



Kód	popis
180229	92 x 67 mm (v x š) LED 4 W teplá biela

Sibus Anthracite



Kód	popis
180234	152 x 67 mm (v x š) LED 4 W teplá biela

Sibus Black



Kód	popis
180232	152 x 67 mm (v x š) LED 4 W teplá biela

Sitta



Kód	popis
180236	220 x 120 mm (v x š) LED 3,5 W teplá biela

Nano



Kód	popis
180620	90 x 65 mm (v x š) LED 1,8 W teplá biela

Mats



Kód	popis
180056	190 x 300 mm (v x š) LED 3,5 W teplá biela

Ilva



Kód	popis
180049	90 x 130 mm (v x š) LED 1,8 W teplá biela



Zmena uhlu
vyžarovania
nahor a nadol



LEN NA
OBJEDNÁVKU

Fidas

IP67



Kód	popis
180044	68 x 70 mm (v x š) LED 1,2 W teplá biela

Boaz



Kód	popis
180039	107 x 70 mm (v x š) LED 1,8W teplá biela

Palm



Kód	popis
180011	60 x 100 mm (v x š) LED 1 W teplá biela

Polaris



Kód	popis
180576	35 x 145 mm (v x š) LED 6 W teplá biela

Kuma

LIGHTPRO



Kód	popis
180577	35 x 145 mm (v x š) LED 6 W teplá biela

Tiga DL

IP67



Kód	popis
180012	88 x 63 mm (v x š) LED 4,2 W teplá biela

Onyx 20

IP67



Kód	popis
180032	33 x 20 mm (v x š) LED 0,3 W teplá biela

Ixion



Kód	popis
180028	110 x 110 mm (v x š) LED 9 W teplá biela

Bodové svetlá vstavané

Alpha biela

IP67



Kód	popis
180520	46 x 44 mm (v x š) LED 0,5 W biela

Alpha teplá biela

Garden
Lights

IP67



Kód	popis
180425	46 x 44 mm (v x š) LED 0,5 W teplá biela

Alpha modrá

IP67



Kód	popis
180430	46 x 42 mm (v x š) LED 0,5 W modrá

Brevus

IP67



Kód	popis
180120	52 x 70 mm (v x š) LED 1 W biela

Sirius

IP67



Kód	popis
180405	52 x 70 mm (v x š) LED 1 W teplá biela

Sirius Blue

IP67



Kód	popis
180525	52 x 70 mm (v x š) LED 1 W modrá

Larch

IP67



Kód	popis
180060	52 x 70 mm (v x š) LED 1 W teplá biela

Larch SET

IP67



Kód	popis
180065	55 x 70 mm (v x š) 3x LED 1 W teplá biela

Astrum

IP67



Kód	popis
180145	28 x 40 mm (v x š) LED 0,3 W biela

Astrum modrá

IP67



Kód	popis
180160	28 x 40 mm (v x š) LED 0,3 W modrá



Umbra

Kód	popis
180157	85 x 105 mm (v x š) LED 2,6 W teplá biela



Gavia



Kód	popis
180415	112 x 96 mm (v x š) LED 2 W



Birch



Kód	popis
180050	45 x 40 mm (v x š) LED 0,5 W teplá biela



Birch SET



Kód	popis
180055	45 x 40 mm (v x š) LED 0,5 W teplá biela



Acis



Kód	popis
180037	20 x 40 mm (v x š) LED 0,2 W teplá biela



Leda



Kód	popis
180410	52 x 70 mm (v x š) LED 1 W teplá biela



Carbo (Elara)



Kód	popis
180420	115 x 115 mm (v x š) LED 2 W



Atria



Kód	popis
180450	42 x 40 mm (v x š) LED 0,5 W teplá biela



Rubum Plus SMART



Kód	popis
180625S	100 x 155 mm (v x š) LED 5 W RGB



Rubum



Kód	popis
180625	110 x 160 mm (v x š) LED 5 W teplá biela



Možnosť prepínania:
biela / studená biela



LEN NA
OBJEDNÁVKU

Bodové svetlá vstavané



Agate

IP67

Kód	popis
180585	110 x 160 mm (v x š) LED 2,6 W teplá biela



Atik R1

LIGHTPRO

IP67

Kód	popis
180591	115 x 120 mm (v x š) LED 9 W teplá biela



Onyx 60 R1

IP67

Kód	popis
180121	42 x 75 mm (v x š) LED 1 W teplá biela



Onyx 60 R3

IP67

Kód	popis
180125	45 x 75 mm (v x š) LED 1 W teplá biela



Onyx 60 R4

IP67

Kód	popis
180165	45 x 75 mm (v x š) LED 1 W teplá biela



Onyx 90 R1

IP67

Kód	popis
180166	45 x 105 mm (v x š) LED 2 W teplá biela



Onyx 30 R1

IP67

Kód	popis
180123	40 x 45 mm (v x š) LED 0,5 W teplá biela



Nomia

IP67

Kód	popis
180033	125 x 90 mm (v x š) LED 3 W teplá biela

Round 30 Plus



Round 40 Plus



Round 50



Kód	popis
180630S	ø 300 mm LED 2 W RGB

Kód	popis
180635S	ø 400 mm LED 3 W RGB

Kód	popis
180640	ø 500 mm LED 4 W RGB

OVAL 28



Flat 40



Kód	popis
180655	170 x 280 mm (v x š) LED 2 W RGB



Kód	popis
180047	400 x 290 mm (v x š) LED 2 W RGB

Linea 1 LED reťaz



Kód	popis
180545	30 x 5 mm (v x š) LED 1,8 W teplá biela

Partylights



Kód	popis
180057	95 x 50 mm (v x š) LED 8 W teplá biela

Linea all seasons reťaz



Kód	popis
180051	30 x 6 mm (v x š) LED 4,5 W teplá biela

LED pás 15 m



Kód	popis
1809990	15 x 10 mm (v x š) LED 2,2 W teplá biela





Kód	popis
180985	Transformátor 24 W



Kód	popis
6210011	Transformátor 60 W



Kód	popis
1809800	Transformátor 150 W

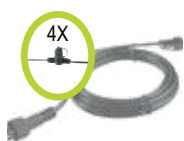

Kód	popis
180735	Hlavný kábel SPT-1W 10 m + 4 konektory

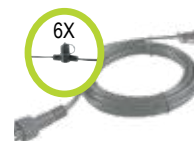

Kód	popis
180740	Hlavný kábel SPT-3W 15 m + 6 konektorov



Kód	popis
180750	Predlžovací kábel SPT-1W 6 m, max. 120 W



Kód	popis
180745	Predlžovací kábel SPT-3W 10 m, max. 150 W



Kód	popis
180790	Spojka SPT-1W



Kód	popis
180785	Spojka SPT-3W



Kód	popis
180755	Odbočka SPT-1W



Kód	popis
180760	Odbočka SPT-3W



Kód	popis
180775	Káblová rozbočka SPT-2W



Kód	popis
180781	Ovládač Switch Plus Bluetooth



Kód	popis
180780	Sada DO + prijímač max. 150 W



Kód	popis
180770	Prijímač vonkajší max. 150 W



Kód	popis
180530	Súmrakový prog. senzor max. 150 W



Kód	popis
180765	Pohybový senzor max. 60 W



Kód	popis
180984	Transformátor 100 W Touch + timer



LiGHTPRO

Kód	popis
180746	Predlžovací kábel 1 m SPT-2



Kód	popis
180747	Predlžovací kábel 3 m SPT-2



Kód	popis
180983	Predlžovací kábel pre súmr. senzor 6 m, transformátor + timer 60 W



Kód	popis
180738	Hlavný kábel 200 m - režeme (bm) max. 150 W



Kód	popis
180739	Hlavný kábel 200 m max. 150 W



Kód	popis
180736	Hlavný kábel 50 m max. 150 W



Kód	popis
180758	Odbočka typ M-Y



Kód	popis
180757	Odbočka typ M-M



Kód	popis
180756	Odbočka typ F



Kód	popis
180759	Ovládač Switch NXT Bluetooth

Kód	popis
180036	Gateway Smart



Kód	popis
180034	Pohybový senzor Smart

Kód	popis
180019	Prijímač



Kód	popis
180018	Sada diaľkového ovládača a prijímača

Kód	popis
180017	Pohybový senzor



Náhradné svetelné zdroje

Informujte sa o type a dostupnosti potrebných náhradných dielov u predajcu.

Mramor biely



Kód	frakcia	balenie
919005	4/8 mm	25 kg
919000	4/8 mm	BB
919003	8/16 mm	25 kg
919004	8/16 mm	BB
919002	16/32 mm	25 kg
919001	16/32 mm	BB

Gneis kamenná kôra



Kód	frakcia	balenie
89107	8/16 mm	25 kg
89102	8/16 mm	BB
89101	11/32 mm	25 kg
89104	11/32 mm	BB
89105	32/63 mm	25 kg
89103	32/63 mm	BB

Šedá kamenná štiepka



Kód	frakcia	balenie
92054	15/40 mm	25 kg
92055	15/40 mm	BB
92065	40/80 mm	BB

Žula biela



Kód	frakcia	balenie
92031	8/16 mm	25 kg
92033	8/16 mm	BB
92035	16/22 mm	25 kg
92034	16/22 mm	BB

Vápenec žltobiely



Kód	frakcia	balenie
87166	8/16 mm	25 kg
87165	8/16 mm	BB

Vápenec ružový



Kód	frakcia	balenie
87186	8/16 mm	25 kg
87184	8/16 mm	BB

Serpentinit

Kód	frakcia	balenie
89141	16/22 mm	25 kg

Kamenná štiepka zlatá

Kód	frakcia	balenie
92059	16/32 mm	25 kg
92058	16/32 mm	BB
92060	32/63 mm	BB

Kameň Tufový Žltý

Kód	frakcia	balenie
85150	8/20 mm	25 kg
85151	8/20 mm	BB

Kameň Tufový Ryolit

Kód	frakcia	balenie
85160	8/20 mm	25 kg
85161	8/20 mm	BB

Atlas Red

Kód	frakcia	balenie
91859	20/28 mm	BB

Lávový kameň Lapillo**NEW**

Kód	frakcia	balenie
8046	10/16 mm	33 l
8047	10/16 mm	BB
8033	20/70 mm	33 l
8037	20/70 mm	BB

Pemza**NEW**

Kód	frakcia	balenie
8054	7/14 mm	BB
8056	7/14 mm	50 l

Zeolit



Kód	frakcia	balenie
89022	4/8 mm	25 kg

Amfibolit



Kód	frakcia	balenie
89139	11/22 mm	BB

Čadič čierny



Kód	frakcia	balenie
89408	16/32 mm	BB

Rosso Verona



Kód	frakcia	balenie
91998	16/22 mm	25 kg
91997	16/22 mm	BB

Giallo Mori



Kód	frakcia	balenie
94021	16/22 mm	25 kg
91992	16/22 mm	BB

Nero Ebano



Kód	frakcia	balenie
94023	16/22 mm	25 kg
89868	16/22 mm	BB

Silver flat

Kód	frakcia	balenie
920431	40/60 mm	25 kg
920432	40/60 mm	BB

Firde Cristallo

Kód	frakcia	balenie
92103	10/20 mm	25 kg
92101	10/20 mm	BB
92104	20/40 mm	25 kg
92102	20/40 mm	BB

Botticino

Kód	frakcia	balenie
89853	15/25 mm	25 kg
89854	15/25 mm	BB
89852	20/50 mm	25 kg

Gialo Mori

Kód	frakcia	balenie
89830	15/25 mm	25 kg
89831	15/25 mm	BB

Thassos biely mramor

Kód	frakcia	balenie
91900	10/20 mm	25 kg
91901	10/20 mm	BB
91902	20/40 mm	25 kg
91903	20/40 mm	BB
94011	40/80 mm	25 kg
91905	40/80 mm	BB

Atlas Red

Kód	frakcia	balenie
91980	10/20 mm	25 kg
91974	10/20 mm	BB
91982	20/40 mm	25 kg
91975	20/40 mm	BB

Okruhliaky

Atlas Green



Kód	frakcia	balenie
91984	10/20 mm	25 kg
91977	10/20 mm	BB
91986	20/40 mm	25 kg
91978	20/40 mm	BB

Žula okruhliak



Kód	frakcia	balenie
89400	30/70 mm	BB
89402	50/100 mm	BB

Bardiglio



Kód	frakcia	balenie
91995	15/25 mm	25 kg
89861	15/25 mm	BB
91996	20/50 mm	25 kg

Nero Ebano



Kód	frakcia	balenie
89840	15/25 mm	25 kg
89838	15/25 mm	BB
89843	20/50 mm	25 kg
89844	20/50 mm	BB

Rosso Verona



Kód	frakcia	balenie
89850	15/25 mm	25 kg
89859	15/25 mm	BB
89851	20/50 mm	25 kg

Verde Alpi



Kód	frakcia	balenie
89855	15/25 mm	25 kg
89856	20/50 mm	25 kg

Granite

Kód	frakcia	balenie
91858	20/40 mm	25 kg
91848	20/40 mm	BB
92106	40/60 mm	25 kg
91923	40/60 mm	BB

Granite Balls

Kód	frakcia	balenie
91972	40/60 mm	25 kg
91866	40/60 mm	kôš

Stripe Onyx

Kód	frakcia	balenie
92105	20/40 mm	25 kg
919071	20/40 mm	BB
919072	40/60 mm	BB

Rainbow

Kód	frakcia	balenie
91963	10/20 mm	25 kg
91896	30/60 mm	25 kg

Praný štrk

Kód	frakcia	balenie
89425	4/8 mm	BB
89426	8/16 mm	BB
89431	16/32 mm	BB

Gneis kusový

Kód	frakcia	balenie
89096	10/50 cm	BB

Vápenec „Chorvátsky“ dierový žltohnedý

Kód	frakcia	balenie
88965	10/50 cm	BB

Žula okruhliak

Kód	frakcia	balenie
91877	10/30 cm	BB
89730	20/40 cm	BB
91881	30/50 cm	BB

Kameň Tufový Ryolit

Kód	frakcia	balenie
85240	10/30 cm	kôš

Kameň tufový žltý Red

Kód	frakcia	balenie
85210	10/30 cm	kôš

Mramor biely kusový

Kód	frakcia	balenie
94012	10/50 cm	kôš

Stripe Onyx

Kód	frakcia	balenie
91830	20/40 cm	kôš

Black Angel

Kód	frakcia	balenie
91820	30/50 cm	kôš

Green Angel omielané

Kód	frakcia	balenie
91810	10/20 cm	kôš
81838	20/40 cm	kôš

Black Angel omielané

Kód	frakcia	balenie
91800	10/20 cm	kôš
91837	20/40 cm	kôš

Stripe Onyx omielané

Kód	frakcia	balenie
91840	20/40 cm	kôš

Granite Balls omielané

Kód	frakcia	balenie
91809	20/30 cm	kôš

Red Spaghetti

Kód	frakcia	balenie
91814	20/40 cm	kôš

Red Lava

Kód	frakcia	balenie
91812	20/40 cm	kôš

Skaly

Moonstone



Kód	frakcia	balenie
88970	20/40 cm	kôš

Púštna ruža



Kód	frakcia	balenie
91645	rôzna	

Pure White



Kód	frakcia	balenie
93071	10/30 cm	kôš

Vápenec grécky dierový



Kód	frakcia	balenie
91685	20/40 cm	kôš

Serpentinit



Kód	frakcia	balenie
89143	30/50 cm	kôš

Andezit A4 murovací



Kód	frakcia	balenie
87468	3/6 cm	kôš
87469	6/12 cm	kôš

Gneis murovací



Kód	frakcia	balenie
89108	6/10 cm	paleta

Desert Black

Kód	frakcia	balenie
91346	40 - 60 x 35 - 40 x 3 - 4 cm	drevený kôš

Autumn Grey

Kód	frakcia	balenie
91347	40 - 60 x 35 - 40 x 3 - 4 cm	drevený kôš

Golden Leaf

Kód	frakcia	balenie
91348	40 - 60 x 35 - 40 x 3 - 4 cm	drevený kôš

Modak

Kód	frakcia	balenie
91343	40 - 60 x 35 - 40 x 3 - 4 cm	drevený kôš

Mint

Kód	frakcia	balenie
91341	40 - 60 x 35 - 40 x 3 - 4 cm	drevený kôš

Mandana

Kód	frakcia	balenie
91344	40 - 60 x 35 - 40 x 3 - 4 cm	drevený kôš

Raveena

Kód	frakcia	balenie
91345	40 - 60 x 35 - 40 x 3 - 4 cm	drevený kôš

Bridlica tmavošedá

Kód	frakcia	balenie
92032	40 - 80 x 4 - 7 cm	paleta

Šlapáky

Vápenec B4 „Chorvátsky“



Kód	frakcia	balenie
91670	40 - 80 x 4 - 7 cm	paleta

Andezit A4



Kód	frakcia	balenie
89782	40 - 80 x 3 - 6 cm	paleta
89783	40 - 80 x 6 - 11 cm	paleta

Dlažby, kocky, palisády

Autumn Grey



Kód	frakcia	balenie
91552	40 x 40 cm	drevený kôš
91557	60 x 60 cm	drevený kôš
92171	60 x 90 cm	drevený kôš

Golden Leaf



Kód	frakcia	balenie
91550	40 x 40 cm	drevený kôš

Modak



Kód	frakcia	balenie
91562	20 x 20 cm	drevený kôš
91553	40 x 40 cm	drevený kôš
91563	60 x 60 cm	drevený kôš
92172	60 x 90 cm	drevený kôš

Mint



Kód	frakcia	balenie
91551	40 x 40 cm	drevený kôš
91555	60 x 60 cm	drevený kôš
92173	60 x 90 cm	drevený kôš

Dlažby, kocky, palisády

Vápenec B4 „Chorvátsky“



Kód	frakcia	balenie
91660	15 - 40 x 4 - 7 cm	paleta

Andezit A4



Kód	frakcia	balenie
87464	15 - 40 x 3 - 5 cm	paleta
87472	15 - 40 x 5 - 8 cm	paleta

Bridlicová platňa čierna



Kód	frakcia	balenie
92052	100 x 50 x 4 - 6 cm	paleta

Bridlicová palisáda čierna



Kód	frakcia	balenie
92061	100 x 10 x 6 - 10 cm	paleta

Žula palisáda



Kód	frakcia	balenie
92037	100 x 10 x 10 cm	paleta
92038	150 x 12 x 12 cm	paleta

Žula kocka



Kód	frakcia	balenie
89749	5 x 6 cm	BB
92036	8 x 10 cm	BB
88180	15 x 17 cm	BB

Tufový blok

NEW



Kód	frakcia	balenie
8028	37 x 11 x 11 cm	paleta
8029	37 x 20 x 11 cm	paleta









T - TAKÁCS, s.r.o.
Hlavná 151
900 29 Nová Dedinka



+421 2 402 080 20
info@takacs.sk
www.takacs.sk

T.TAKÁCS
VEĽKOOBCHOD